



# Troubleshooting guide

## Y series and in.xe



Possible error codes

---

Error code explanation

---

Step by step troubleshooting



---

## Table of contents

Warning .....	2
Troubleshooting .....	3
- Diagnostic LEDs description in.yj .....	3
- Possible error codes on in.yj, in.ye, in.yt and in.xe control systems .....	6
- Hr error message .....	7
- HL error message .....	8
- Prr error message .....	11
- FLO error message .....	12
- UPL error message .....	13
- AOH error message .....	13
- OH error message .....	14
- Pump 1, 2, 3, 4, 5 or the blower is not working .....	15
- The circulation pump is not working .....	19
- The ozonator is not working .....	19
- Nothing seems to be working (North American models) .....	20
- Nothing seems to be working (CE/AS/NZS models) or (European models) .....	22
- The spa is not heating .....	24
- The keypad does not seem to work .....	26
- GFCI/RCD trips .....	27



## Warning



### **WARNINGS:**

Before installing or connecting the unit, please read the following.

- \* FOR UNITS FOR USE IN OTHER THAN SINGLE-FAMILY DWELLINGS, A CLEARLY LABELED EMERGENCY SWITCH SHALL BE PROVIDED AS PART OF THE INSTALLATION. THE SWITCH SHALL BE READILY ACCESSIBLE TO THE OCCUPANTS AND SHALL BE INSTALLED AT LEAST 5' (1.52 M) AWAY, ADJACENT TO, AND WITHIN SIGHT OF THE UNIT.
- \* ANY DAMAGED CABLE MUST BE IMMEDIATELY REPLACED BY QUALIFIED PERSONNEL.
- \* TURN POWER OFF BEFORE SERVICING OR MODIFYING ANY CABLE CONNECTIONS IN THIS UNIT.
- \* TO PREVENT ELECTRIC SHOCK HAZARD AND/OR WATER DAMAGE TO THIS CONTROL, ALL UNUSED BUSHING CONDUITS MUST BE PLUGGED WITH THE ATTACHED NIPPLE.
- \* THIS CONTROLLER MUST NOT BE INSTALLED IN PROXIMITY OF HIGHLY FLAMMABLE MATERIALS.
- \* LOW SUPPLY VOLTAGE OR IMPROPER WIRING MAY CAUSE DAMAGE TO THIS CONTROL SYSTEM. READ AND FOLLOW ALL WIRING INSTRUCTIONS WHEN CONNECTING TO POWER SUPPLY.
- \* THIS PACK CONTAINS NO USER SERVICEABLE PARTS. CONTACT AN AUTHORIZED SERVICE CENTER FOR SERVICE.
- \* ALL CONNECTIONS MUST BE MADE BY A QUALIFIED ELECTRICIAN IN ACCORDANCE WITH THE NATIONAL ELECTRICAL CODE AND ANY STATE, PROVINCIAL OR LOCAL ELECTRICAL CODE IN EFFECT AT THE TIME OF THE INSTALLATION.
- \* PRODUCT MUST BE DISPOSED OF SEPARATELY IN ACCORDANCE WITH LOCAL WASTE DISPOSAL LEGISLATION.
- \* THIS APPLIANCE IS NOT INTENDED FOR USE BY PERSONS (INCLUDING CHILDREN) WITH REDUCED PHYSICAL, SENSORY OR MENTAL CAPABILITIES, OR LACK OF EXPERIENCE AND KNOWLEDGE, UNLESS THEY HAVE BEEN GIVEN SUPERVISION OR INSTRUCTION CONCERNING USE OF THE APPLIANCE BY A PERSON RESPONSIBLE FOR THEIR SAFETY.
- \* CHILDREN SHOULD BE SUPERVISED TO ENSURE THAT THEY DO NOT PLAY WITH THE APPLIANCE.
- \* MEANS FOR DISCONNECTION MUST BE INCORPORATED IN THE FIXED WIRING IN ACCORDANCE WITH THE WIRING RULES.
- \* CAUTION: IN ORDER TO AVOID A HAZARD DUE TO INADVERTENT RESETTING OF THE THERMAL CUT-OUT, THIS APPLIANCE MUST NOT BE SUPPLIED THROUGH AN EXTERNAL SWITCHING DEVICE, SUCH AS A TIMER, OR CONNECTED TO A CIRCUIT THAT IS REGULARLY SWITCHED ON AND OFF BY THE UTILITY.
- \* PARTS CONTAINING LIVE PARTS, EXCEPT PARTS SUPPLIED WITH SAFETY EXTRA-LOW VOLTAGE NOT EXCEEDING 12 V, MUST BE INACCESSIBLE TO A PERSON IN THE BATH OR SPA.
- \* PARTS INCORPORATING ELECTRICAL COMPONENTS, EXCEPT REMOTE CONTROL DEVICES, MUST BE LOCATED OR FIXED SO THAT THEY CANNOT FALL INTO THE BATH OR SPA.
- \* PARTS ARE TO BE INSTALLED IN THE CORRECT ZONE AND EQUIPOTENTIAL BONDING CARRIED-OUT IN ACCORDANCE WITH THE WIRING RULES.
- \* CLEARANCE AND MINIMUM DISTANCE BETWEEN THE VARIOUS PARTS OF THE APPLIANCE AND THE SURROUNDING STRUCTURE ARE NOT SPECIFIED AS LONG AS THEY ARE SUFFICIENT SO THAT THE AMBIENT TEMPERATURE AROUND THE CONTROLLER DOES NOT EXCEED 60°C

Aeware®, Gecko®, and their respective logos are Registered Trademarks of Gecko Alliance Group. in.yj™, in.keys™, in.touch™, in.k200™, in.k400™, in.k450™, in.k600™, K-19™, K-35™, K-8™, in.k1000™, in.k800™, in.k500™, in.k300™, in.flo™, in.put™, in.seal™, in.link™, in.t.cip™, in.stik™, heat.wav™, Y Series™, and their respective logos are Trademarks of Gecko Alliance Group.

All other product or company names that may be mentioned in this publication are tradenames, trademarks or registered trademarks of their respective owners.

## Troubleshooting

### Diagnostic LEDs description in.yj

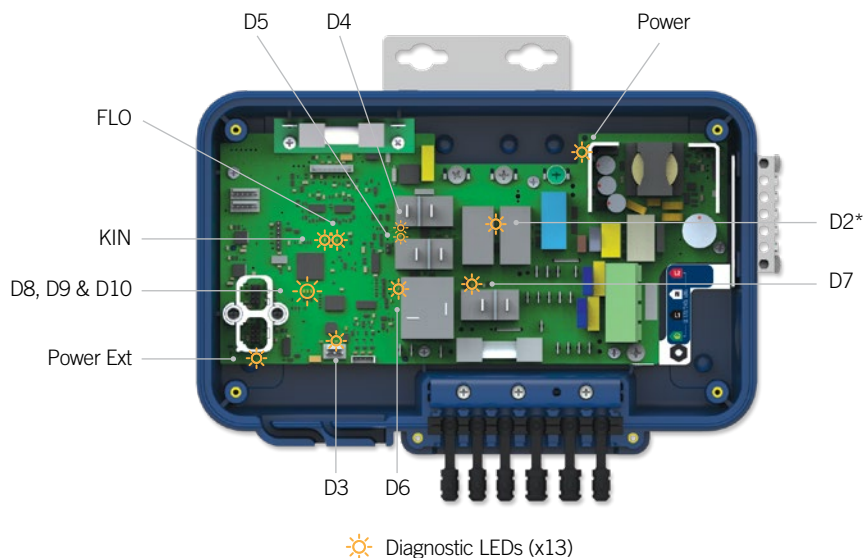

\* D2 designation is not visible on the PCB, D2 is situated between component RD2 and E2.

Case	Designation	Description	Details	Action
1	Power	General 12V power supply status	Should always be ON If OFF, nothing will work. Possible causes:	
			Input not connected	Check the input connection on P12
			Installation main breaker OFF	Check the main breaker of the installation. Go to GFCI/RDC Trips section.
			Short on one connector between 12V line and near signal	Check following connectors in order: P22 (C-pin 6); P17 (CO-pin 6); P38 (RGB-pin 4), P33 (LIGHT-pin 3), P1 (pin 4)
		Issue on board	Change the in.yj-V3 board	
2	Power Ext	External 12V and 5V power supplies status	Should always be ON If OFF, external accessories won't work. Possible causes:	
			Short on one connector between 12V line and near signal	Check following connectors in order: P22 (C-pin 6); P17 (CO-pin6)
			Short on one connector between 5V line and near signal	Check following connectors in order: P22 (C-pin 4); P17 (CO-pin 4); P1 (pin 4); P8 (Pin 1)
3	D8, D9 & D10	MCU status	D8 should always blink, D9 and D10 are always OFF. If not, possible causes:	
			The board is starting (power on)	Wait about 10s
			D8, D9 and D10 flashing in sync: bootloader present, but there is no valid firmware in the MCU memory	Power down the in.yj, insert an in.stik with a valid software and reapply power
			D8 always ON (more than 10s), D9 and D10 are always OFF: the in.yj is in UPL state	Power down the in.yj, insert an in.stik with a valid software and reapply power

Case	Designation	Description	Details	Action
			D8 always ON, D9 flashing and D10 is always OFF: software loading from an in.stik in progress	Wait about 1 minute
			POWER Led is OFF	Go to case #1
			Issue on board	Change the in.yj-V3 board
4	D2	HL Relays (K2-K3) cmd status	Should always be ON If OFF, possible causes:	
			High Limit situation happens	Go to HL section
			Remote heater cable or the Probes cable disconnected	Check remote heater cable or Probe cable
			F2 burnt (on CE models only)	Check F2
5	D6	Pump 1 low relay (K6) cmd status	Should always be ON when the Pump 1 is running in low speed, and OFF otherwise.  If Led ON and pump isn't running:	
			Issue on pump and connection	Check pump connection
			F2 burnt	Check F2
			If Led OFF and pump running:	
			Issue on relay K6	Change the in.yj-V3 board
6	D7	Pump 1 high relay (K7) cmd status	Should always be ON when the Pump 1 is running in high speed, and OFF otherwise.  If Led ON and pump isn't running:	
			Issue on pump and connection	Check pump connection
			F2 burnt	Check F2
			If Led OFF and pump running:	
			Issue on relay K7	Change the in.yj-V3 board
7	D5	Pump 2 relay (K5) cmd status or Kinetic protection (-KR option) relay (K5) cmd status	Should always be ON when the Pump 2 is running, and OFF otherwise.  If Led ON and pump isn't running:	
			Issue on pump and connexion	Check pump connection
			F2 or F4 burnt	Check F2 and F4
			If Led OFF and pump running:	
			Issue on relay K5	Change the in.yj-V3 board
8	D4	Regulation relay (K4) cmd status	Should always be ON when the system is heating and OFF otherwise.  If Led ON and no heating:	
			Issue heater connection	Check heater connection
			F2 burnt (on CE models only)	Check F2
			Issue on remote heater	Change remote heater
			If Led OFF and heating:	
			Issue on relay K4	Change the in.yj-V3 board

## Troubleshooting

Case	Designation	Description	Details	Action
9	FLO	Flow detection status	Should be ON when flow is detected and OFF otherwise.	If a FLO error message, go to FLO section
			If not possible causes:	
			Pump 1 low isn't running	Go to case #5
			The system is running a flow checking sequence	Wait around 2 min
			The flow rate is too low	Make sure the installation respects the flow rate requirements
10	KIN	KINETIC protection status	Should be OFF on normal situation.	If a FLO error message, go to FLO section
			If ON, possible causes:	
			KINETIC state: No flow detected for more than 2 hours	Wait 2 hours and validate the status of the LED KIN another time to confirm that KINETIC error is permanent
			Flashing: internal communication between the remote heater and the pack	n/a
			Issue on remote heater	Change the remote heater
11	D3	Light & RGB cmd status	Is ON only when the Light is turned ON by the user, and OFF otherwise.	
			If not possible causes:	
			No POWER	Go to case #1

### Possible error codes on in.yj, in.ye, in.yt and in.xe control systems

The error codes indicate a failure or problem that must be rectified to guarantee the good function of the system. The error code and the water temperature are displayed alternately on the keypad.

The error messages listed below display on the LCD and LED keypads. If your spa is equipped with a color keypad, please refer your [techbook](#) for more information on error messages.

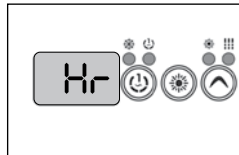

#### **Hr**

An internal error with the system hardware has been detected.



#### **HL**

The water temperature in the water heater has reached 119 °F (48°C).

**Do not enter spa water!**

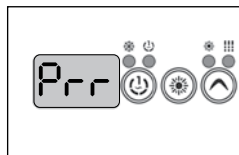

#### **Prr**

The system detects a problem with the regulation probe. The system constantly verifies if the temperatures read by the probe are inside the normal limits.



#### **FLO**

The system has detected no water flow during the main pumps operation.



#### **UPL**

No low-level configuration is present in the control system memory, insert a valid in.stik to program the control unit.



#### **AOH**

The temperature inside the spa skirt is too high and causes an increase of the internal temperature of the control system above normal limits.



#### **OH**

The spas water temperature has reached 108°F (42°C)

**Do not enter spa water!**

---

## Troubleshooting

### Hr error message

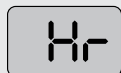

An internal error with the hardware was detected.

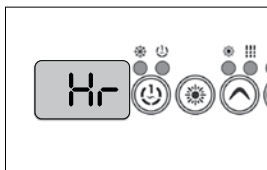

- First, restart the spa system, then, start and stop all pumps and blowers.
- If the error comes back, replace the control system.



### HL error message



The system has stopped because the water temperature in the water heater reached 119 °F (48 °C).



Probe connector (regulation and overheat captor)

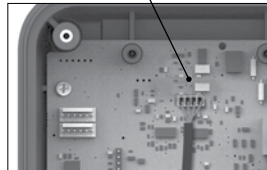

*in.yj-re*

**Warning! Do the following operations with precaution the water heater's body may be very hot.**

- Measure the water temperature with an DIGITAL thermometer and compare the measured temperature with the one displayed on the keypad.

**If the measured temperature is inferior to 119 °F (48 °C):**

*For the in.yj-re control systems:*

- Verify that the regulation and overheat probe is correctly placed in the plumbing.  
If it is, assure yourself that nothing is blocking the water flow (closed valves or clogged filter).
- Verify that the probe is correctly plugged into the probe connector (P40).
- Turn the spa off and turn it back on to reinitialise the system.
- If error HL persists replace the probe.
- If error HL persists after the probe replacement, replace the control system.

**If the measured temperature is below 119 °F (48°C) and the water heater's body is hot:**

- With care, verify the water heater's body temperature. If it is hot, assure yourself that nothing is blocking the water flow (closed valves or dirty filter).
- Turn the spa off and turn it back on to reinitialise the system.
- If error HL persists replace the water heater.
- If error HL persists replace the control system.

## Troubleshooting

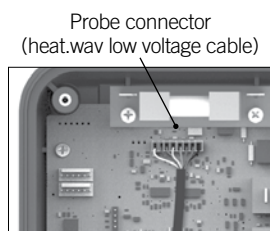

**in.yj**

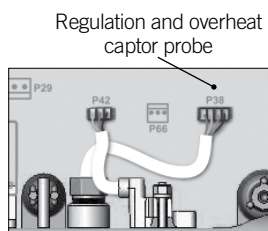

**in.ye and in.yt**

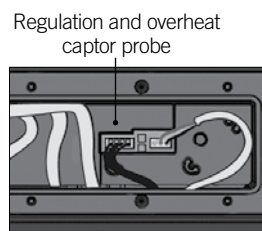

**in.xe**

**If the measured temperature is below 119 °F (48°C) and the water heater's body is not hot:**

*For the in.yj control systems:*

- Verify that the heat.wav low voltage cable is correctly plugged into the probe connector (P1).

*For the in.ye, in.yt and in.xe control systems:*

- Verify that the regulation and overheat captor are plugged in correctly.
- Turn the spa off and turn it back on to reinitialise the system.
- If error HL persists replace the water heater.
- If error HL persists replace the control system.

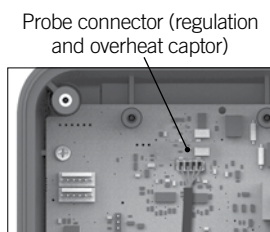

**in.yj-re**

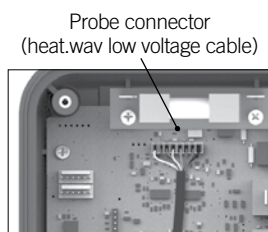

**in.yj**

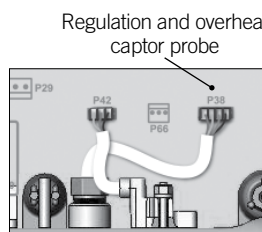

**in.ye and in.yt**

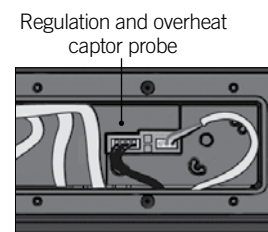

**in.xe**

**If the measured temperature is 119 °F (48°C) or above and does not correspond to the one displayed on the keypad:**

*For the in.yj-re control systems:*

- Verify that the probe is correctly plugged into the probe connector (P40).
- If the cable is correctly plugged in, replace the probe.
- Turn the spa off and turn it back on to reinitialise the system.
- If error HL persists replace the control system.

*For the in.yj control systems:*

- Verify that the heat.wav low voltage cable is correctly plugged into the probe connector (P1).

*For the in.ye, in.yt and in.xe control systems:*

- Verify that the regulation and overheat captor are plugged in correctly.
- If the cable is correctly plugged in, replace the water heater.
- Turn the spa off and turn it back on to reinitialise the system.
- If error HL persists replace the control system.

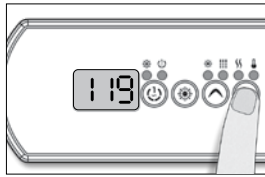

Probe connector (regulation and overheat captor)

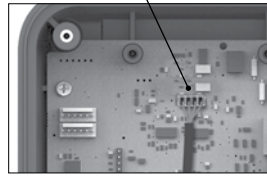

**in.yj-re**

**If the measured temperature is 119 °F (48°C) or above and the exterior temperature is very high:**

- Take of the spa lid (even for the night).
- Start the blowers if the spa is equipped with it.
- Wait that the spa cools down (add cold water if needed).
- Turn the spa off and turn it back on to reinitialise the system.

**If the measured temperature is 119 °F (48°C) or above and the exterior temperature is not the cause:**

*For the in.yj-re control systems:*

- Verify that the probe is correctly plugged into the probe connector (P40).
- Set the consigned value to a temperature lower than the actual water temperature.  
The water heater indicator should turn off.
- Turn off all the pumps. If a pump is still running, replace the control system.
- Turn the spa off and turn it back on to reinitialise the system.
- If error HL persists replace the probe.
- If error HL persists after the probe replacement, replace the control system.

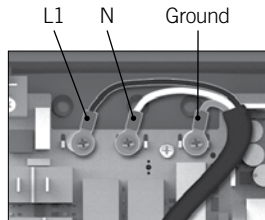

**in.yj**

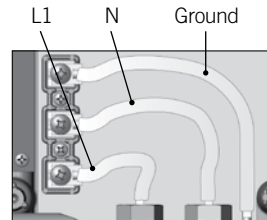

**in.ye and in.yt**

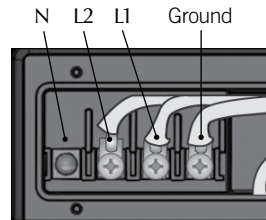

**in.xe**

**If the measured temperature is 119 °F (48°C) or above and the exterior temperature is not the cause:**

*For the in.yj, in.ye, in.yt and in.xe control systems:*

- Set the consigned value to a temperature lower than the actual water temperature.  
The water heater indicator should turn off.
- Use the voltmeter on the water heater's terminal block to measure the tension between the line (L1) and the ground.
- If you measure 120 V or 240 V, replace the control system.
- If you do not measure 120 V or 240 V, the pump may be heating the water excessively during the filtration cycle.
- Reduce the length of the filtration cycle.
- Turn the spa off and turn it back on.

## Troubleshooting

### Prr error message

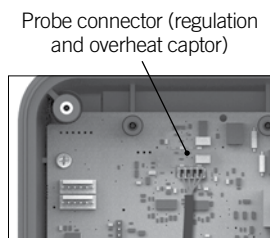
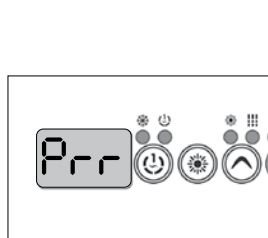

Problem with the regulation probe



**in.yj-re**

*For the in.yj-re control systems:*

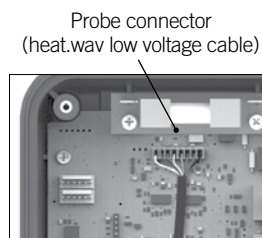
- Verify that the probe is plugged in correctly to the probe connector (P40).
- Replace the probe if problem persists.
- If error persists after the probe replacement, replace the control system.



**in.yj**

*For the in.yj control systems:*

- Verify that the heat.wav low voltage cable is correctly plugged into the probe connector (P1).
- If error persists replace the water heater.
- If error persists replace the control system

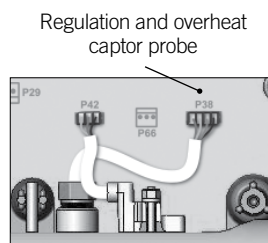

**in.ye and in.yt**

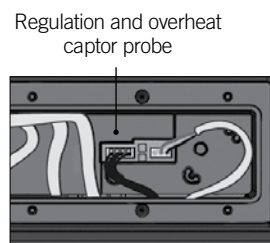

**in.xe**

*For the in.ye, in.yt and in.xe control systems:*

- Verify that the regulation and overheat captor probe (situated over the heater) are plugged in correctly.
- Replace the water heater if the problem persists.
- Replace the control system if the problem persists.

## FLO error message

The system has detected no water flow during the main pumps operation.

Ensure that the selected low-level is compatible with your spa's material. Verify that the pump linked to the heating is configured correctly. (See HP option in the dealer menu option. For more details on the HP option, refer to the manual [Start up guide and basic configuration for Y series and in.xe](#)).

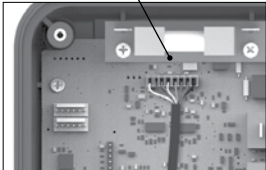
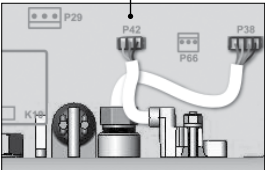
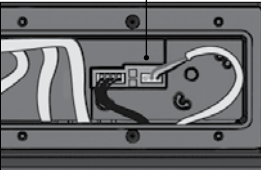
	<p style="font-size: 10px;">Probe connector (heat.wav low voltage cable)</p>  <p style="font-weight: bold; font-size: 12px;">in.yj</p>	<p style="font-size: 10px;">in.flo cable</p>  <p style="font-weight: bold; font-size: 12px;">in.ye and in.yt</p>	<p style="font-size: 10px;">in.flo cable</p>  <p style="font-weight: bold; font-size: 12px;">in.xe</p>
<ul style="list-style-type: none"> <li>Ensure the water circulation valves are open and that the water level is high enough.</li> <li>Verify that nothing is blocking the filter.</li> <li>Ensure the flow is adequate (minimum 68 LPM/ 18 GPM).</li> </ul>	<ul style="list-style-type: none"> <li>Ensure no air bubbles are trapped in the plumbing circuits of the device (the pumps may be making abnormal sounds). If bubbles have formed, start the pump, unscrew slowly one of the union nuts to free the air trapped in the plumbing. Tighten back the nut once done.</li> </ul>	<ul style="list-style-type: none"> <li>Ensure the pump linked to the water heater (main pump) is running.</li> <li>For in.yj control systems, verify the water heater's low voltage cable is linked correctly to the probe connector (P1).</li> </ul>	<ul style="list-style-type: none"> <li>For the in.ye, in.yt and in.xe control systems, ensure the in.flo cable (located over the water heater) is plugged in correctly.</li> <li>If the problem persists, replace the water heater.</li> <li>If the problem still persists, replace the control system</li> </ul>

## Troubleshooting

### UPL error message



No low-level configuration is present in the control system memory!



- Insert a valid in.stik to program the low-level configurations in the control unit. Without them, the system cannot function.
- For technical assistance, use our toll-free number (1 800 784-3256)

*Note: this line is dedicated to assist authorized service technicians and dealers only.*

### AOH error message



The temperature inside the spa skirt is too high.



- Remove the spa skirt and let the water temperature cool down until the error disappears.
- Replace the control system if the problem persists.

### OH error message



The spas water temperature has reached 108°F (42°C).



- Measure the water temperature with a DIGITAL thermometer and compare the measured temperature with the one displayed on the keypad.

#### **If the measured temperature is different from the one displayed on the keypad (inferior to 108°F / 42°C):**

- Turn the spa off and turn it back on to reinitialise the system.
- For in.yj-re control system, if the error persists, replace the probe.
- For in.yj, in.ye, in.yt and in.xe control systems, if the error persists, replace the water heater.
- If error still persists, replace control system.

#### **If the measured temperature corresponds (superior to 108°F / 42°C) and the exterior temperature is high:**

- Remove the spa lid and let the spa cool down.
- Add cold water and reduce filtration cycle length.
- If error still persists, replace control system.

#### **If the measured temperature corresponds (superior to 108 °F / 42 °C) and the exterior temperature is not high:**

- Set the consigned value to a temperature below that of the spa water.  
The keypad's water heater indicator should turn off.
- Turn off all pumps\*. If one of the pumps is still running, replace the control system.
- The pump may be excessively heating the water during the filtration cycle. Reduce filtration cycle length.

*\* Note: the main pump may not turn off if you are currently running a filtration cycle.*

## Troubleshooting

### Pump 1, 2, 3, 4, 5 or the blower is not working

If pump 1, 2, 3, 4, 5 or the blower is not working:

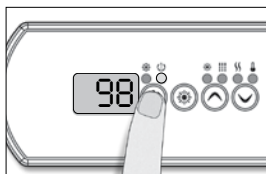

- Verify if an error message is displayed on the keypad. If so, refer to the corresponding section.
- Ensure the selected low-level configuration is compatible with your spa material.
- Verify the indicator linked to your pump and blower on the keypad turns on when you press on the corresponding key.

#### If the indicator does not light up:

- Use a replacement keypad to verify the state of the original.
- Replace the keypad if defective.
- If the keypad works correctly, replace the control system.

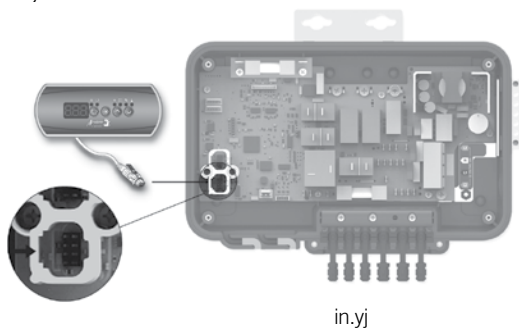

in.yj

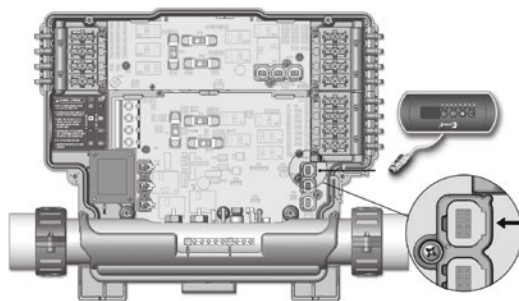

in.ye and in.yt

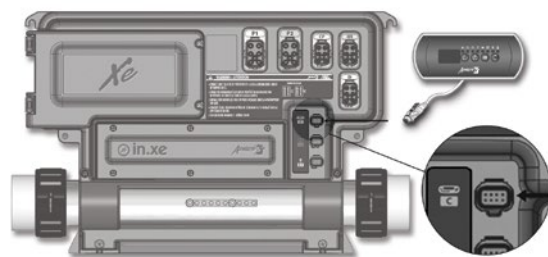

in.xe

#### If the indicator lights up:

- Verify your pump is working on both speeds (if dual speed pump) and your accessories works correctly (ex: blower).



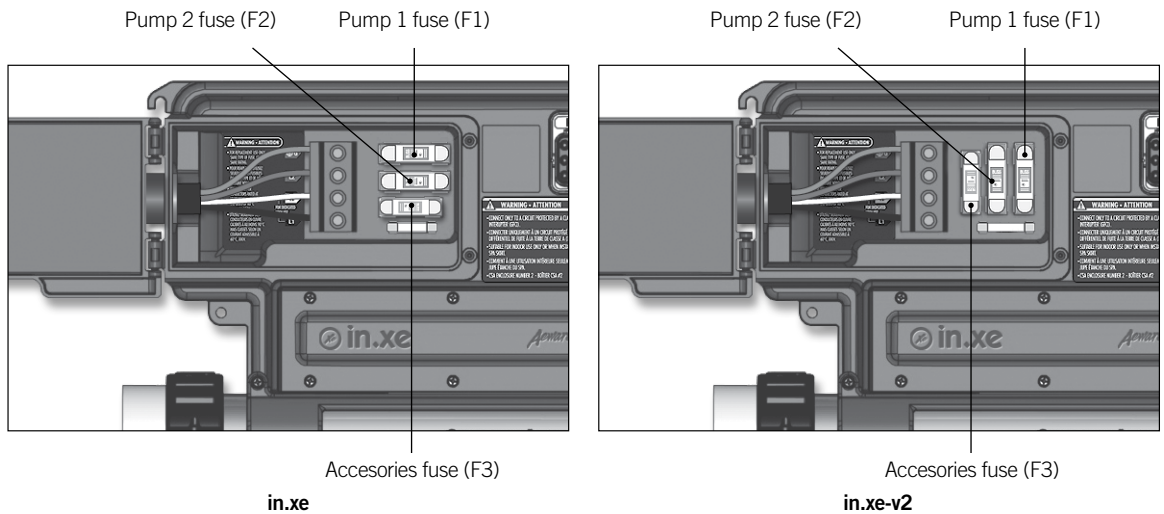
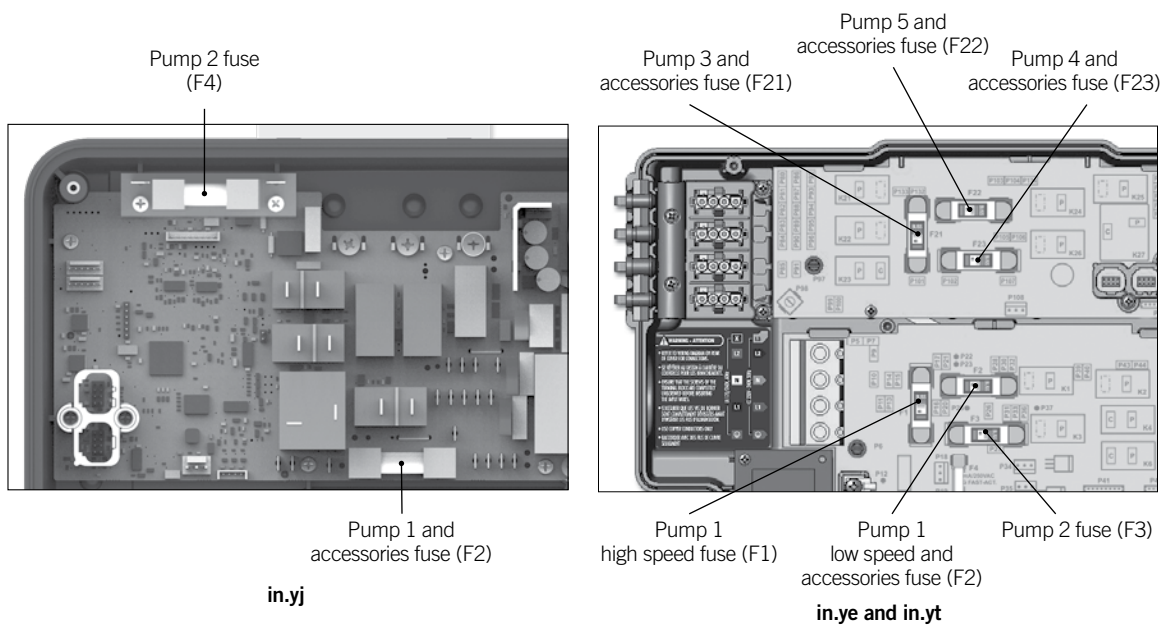

**If your pump is not working on both speeds (if dual speed pump) or if your accessories (ex: blower) is not working:**

- Replace the problematic fuse linked to your pump or your accessory (ex: blower) by a new one.
- Verify the fuse replacement rectifies the problem.

*Note: The accessories linked to every fuse are indicated as an example, every OEM has its own configurations.*

## Troubleshooting

**If replacing the fuse has no effect, or if the pump only works on one speed, measure the tension of the corresponding connector:**

- Activate your pump on the problematic speed or the accessory (ex: blower).
- Referring to your control systems connexion diagram, measure the tension between: the pump or blower output and its return.

You should measure:

120 V for a 120 V pump or accessory

240 V for a 240 V pump or accessory

**If the tension is compliant, verify the cables and connectors and replace if necessary. If need be, replace the pump or the accessory.**

**If the tension is not compliant, replace the control system.**

### Measuring tension on in.yj:

*Example: your pump 1 high speed (240V) is not working.*

Referring to the connexion diagram you may see that the pump 1 output is connected on K7-P (Pump 1 high speed) and the return should be on one of the TAB of line 2 (P14, P15, P16 or P37) for a 240V pump and on one of the Neutral TAB (P18, P19, P20, P21 or P35) for a 120V pump.

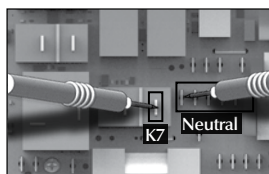

in.yj

Measure the tension between the K7-P and your return (Line 2 or Neutral), you should measure:

120 V for a 120 V pump or accessory

240 V for a 240 V pump or accessory

### Measuring tension on in.ye and in.yt:

*Example: your pump 1 high speed (240V) is not working.*

Referring to the connexion diagram you may see that the pump 1 output is linked to the A3 connector (pump 1 output).

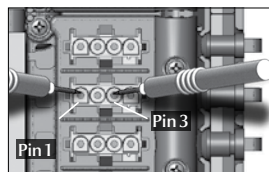

in.ye and in.yt

Measure the tension between pin 1 (pump 1 high speed output) and pin 3 (return), you should measure:

120 V for a 120 V pump or accessory

240 V for a 240 V pump or accessory

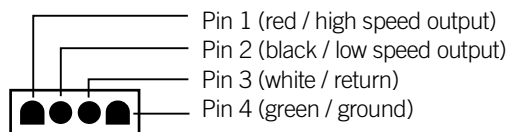

## Measuring tension on in.xe:

*Example: your pump 1 high speed (240V) is not working.*

Referring to the front connector identifiers, you may see the pump 1 output is on the P1 connector.

You may then refer to the "Connector pin out" on the front of the in.xe, you will notice the output for your pump 1 is on pins 2 and 3 (pump 1 high speed 20A and 15A) and the return should be on pin 1 (line 2) for a 240V pump and on pin 5 (neutral) for a 120V pump.

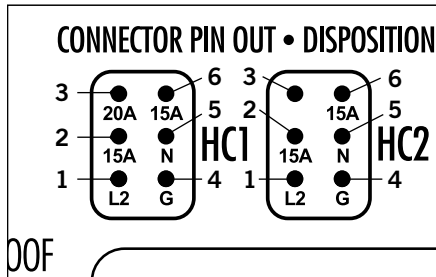

HC1

Pin 1 (Line 2)  
 Pin 2 (Output (1) high speed, 15A)  
 Pin 3 (Output (1) high speed, 20A)  
 Pin 4 (Ground)  
 Pin 5 (Neutral)  
 Pin 6 (Output (1) low speed, 15A)

HC2

Pin 1 (Line 2)  
 Pin 2 (Output (2) high speed, 15A)  
 Pin 3 (NC)  
 Pin 4 (Ground)  
 Pin 5 (Neutral)  
 Pin 6 (Output (3) low speed, 15A)

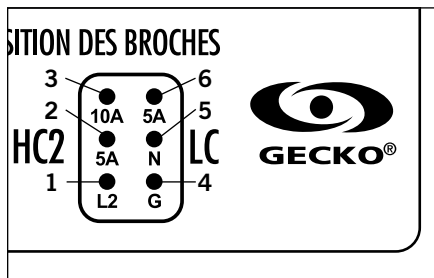

LC (1)

Pin 1 (Line 2)  
 Pin 2 (Output (3), 5A)  
 Pin 3 (Output (3-4), 10A)  
 Pin 4 (Ground)  
 Pin 5 (Neutral)  
 Pin 6 (Output (4), 5A)

LC (2)

Pin 1 (Line 2)  
 Pin 2 (Output (4), 5A)  
 Pin 3 (Output (4), 10A)  
 Pin 4 (Ground)  
 Pin 5 (Neutral)  
 Pin 6 (NC)

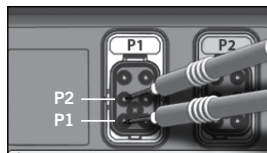

240 V

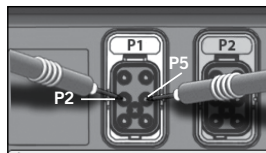

120 V

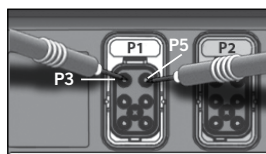
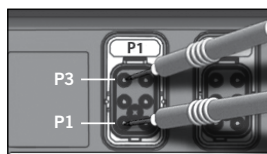

Measure the tension between P1 connector pins 2-3 (output pump 1 high speed 20A and 15A) and pin 1 or 5 (return line 2 or neutral), you should measure:

120 V for a 120 V pump or accessory

240 V for a 240 V pump or accessory

## Troubleshooting

### The circulation pump is not working

#### If the circulation pump is not working:

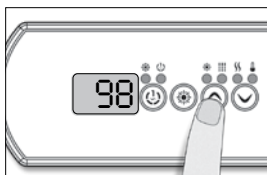

#### If the circulation pump is not working:

- Ensure the selected low-level configuration is compatible with your spas material.
- Start the circulation pump, by setting the consigned temperature 2 °F above the actual water temperature.

#### Measure the tension on the corresponding connector:

- Referring to your control systems connexion diagram, measure the tension between: the output of your circulation pump and its return.

You should measure:

120V for a 120V circulation pump

240V for a 240 V circulation pump

#### If the measured tension is not compliant:

- Replace the accessories fuse.
- If replacing the fuse does not fix the problem, replace the control system.

#### If the measured tension is compliant:

- Replace the circulation pump.

### The ozonator is not working

#### If the ozonator is not working:

**Note:** The ozonator stops automatically when an accessory is started manually (pumps, blower, light).

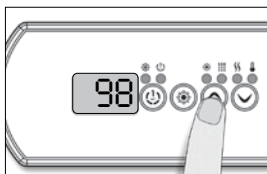

#### If the ozonator is not working:

- Verify the status of the filtration cycle indicator on the keypad display.
- If the «Filtration» indicator flashes, it is to signal that the system has interrupted the filtration cycle. In that case, restart the breaker by cutting off then restarting the power to reinitialise the cycle.
- If not, start the filtration cycle (see your keypads techbook for more information).

#### If the ozonator is not working and the filtration indicator is ON:

- Referring to the connexion digram of your control system, measure the tension between : the ozonator output and its return.

You should measure:

120V for a 120V ozonator

240V for a 240V ozonator

#### If the measured tension is not compliant:

- Replace the accessories fuse.
- If replacing the fuse does not fix the problem, replace the control system.

#### If the measured tension is compliant:

- Replace the ozonator.

## Troubleshooting

### Nothing seems to be working (North American models)

Turn the system off and verify that all screws on the the terminal block are tight.  
Pull on the cables to ensure that they are solidly fixed. Turn the device back on.

#### in.yj

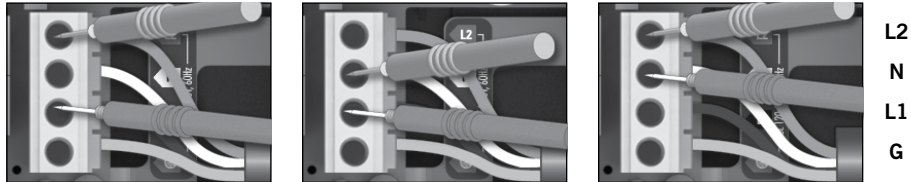

#### in.ye & in.yt

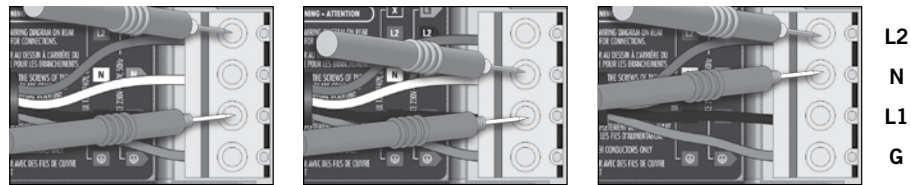

#### in.xe



### For 240 V systems

- On the terminal block, measure the tension between line 1 and line 2. You should measure 240V.
- Measure the tension between line 1 and neutral. You should measure 120V.
- Measure the tension between line 2 and neutral. You should measure 120V.

#### in.yj

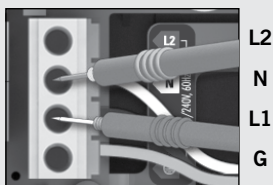

#### in.ye & in.yt

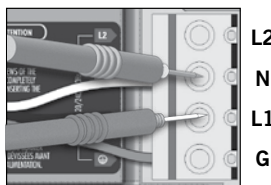

#### in.xe

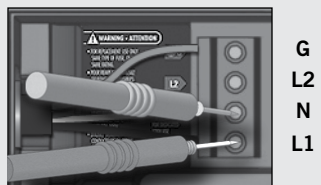

### For 120V systems

- Measure the tension between line 1 and neutral. You should measure 120 V.

**Incorrect readings indicate an electrical cable problem. Call an electrician!**

## Troubleshooting

### If readings are correct:

- Verify that the keypad is linked correctly to the control system.

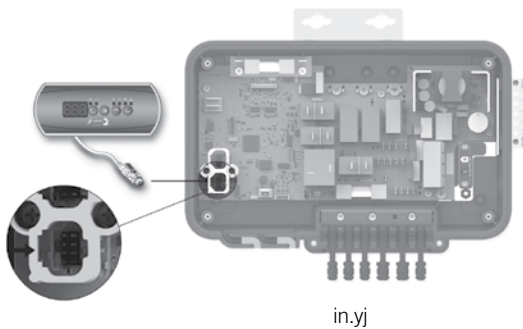

in.yj

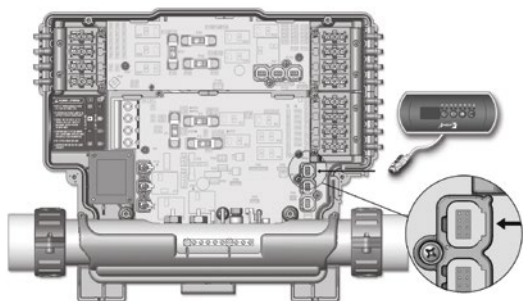

in.ye and in.yt

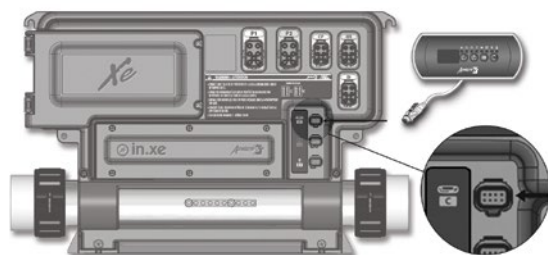

in.xe

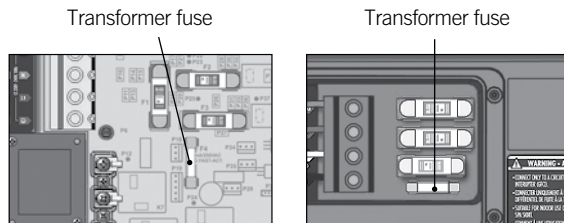

in.ye and in.yt

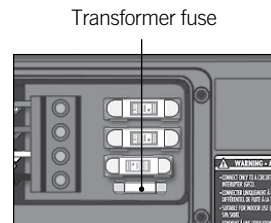

in.xe

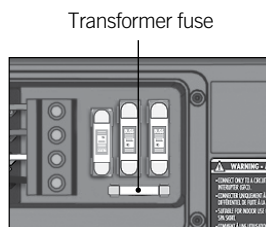

in.xe-v2

### If readings are correct and keypad is linked correctly:

- Verify the transformer fuse. (Available only on in.ye, in.yt and in.xe control systems.)
- Replace the transformer fuse if necessary.
- If problem persists, replace the control system.



## Nothing seems to be working (CE/AS/NZS models) or (European models)

Turn the system off and verify that all screws on the the terminal block are tight. Pull on the cables to ensure that they are solidly fixed. Turn the device back on.

in.yj

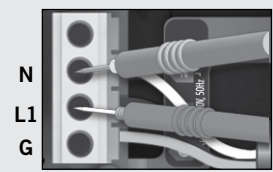

in.ye and in.yt

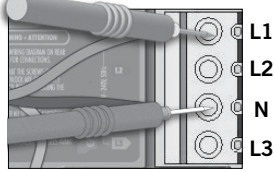

in.xe

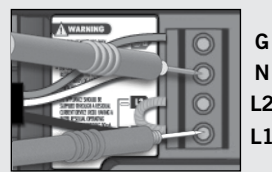

### For single phase system

- Measure the tension between line 1 (L1) and neutral (N).
- You should measure 230 V.

in.yj

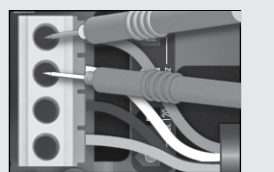
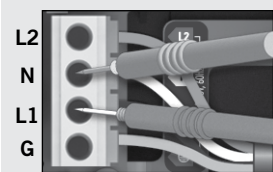

in.ye and in.yt

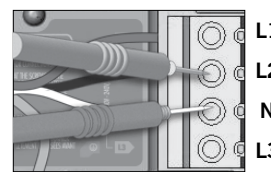
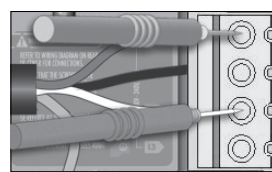

### For dual phase systems

- Measure the tension between line 1 (L1) and neutral (N) and between line 2 (L2) and neutral (N).
- You should measure 230V in both cases.

in.xe

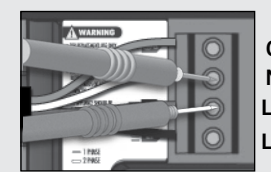
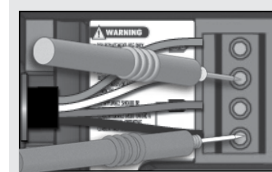

in.ye and in.yt

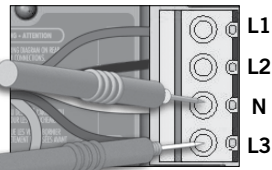
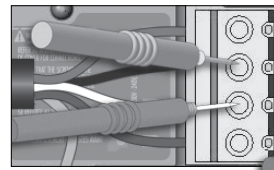
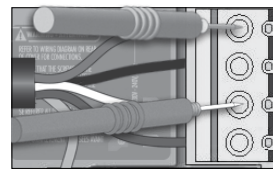

### For triple phase system

- Measure the tension between line 1 (L1) and neutral (N) and between line 2 (L2) and neutral (N) and between line 3 (L3) and neutral (N).
- You should measure 230V in all cases.

in.ye and in.yt

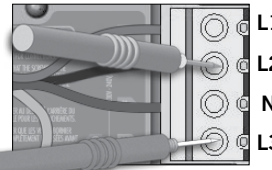
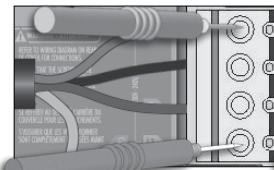
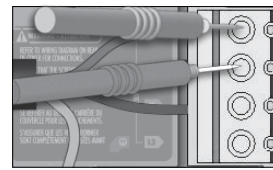

### For delta triple phase system

- Measure the tension between line 1 (L1) and line 2 (L2), between line (L1) and line 3 (L3) and between line 2 (L2) and line 3 (L3).
- You should measure 230V in all cases.

**Incorrect readings indicate an electrical cable problem. Call an electrician!**

## Troubleshooting

### If tension readings are correct:

- Verify that the keypad is linked correctly to the control system.

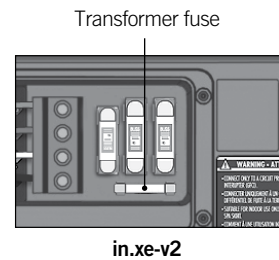
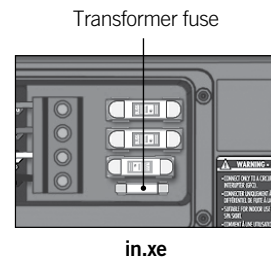
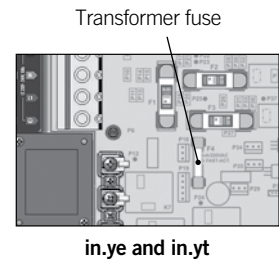
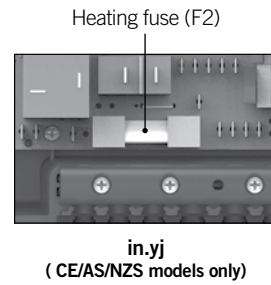
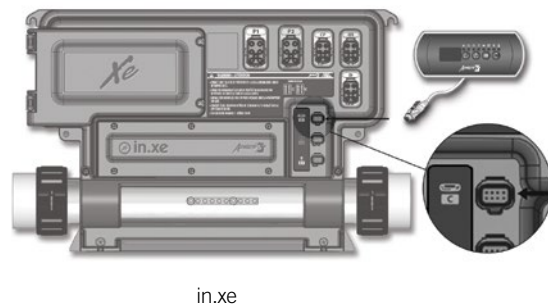
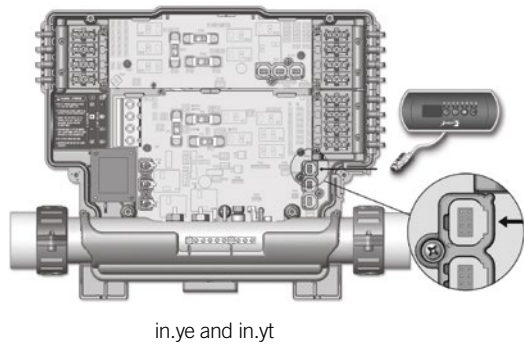
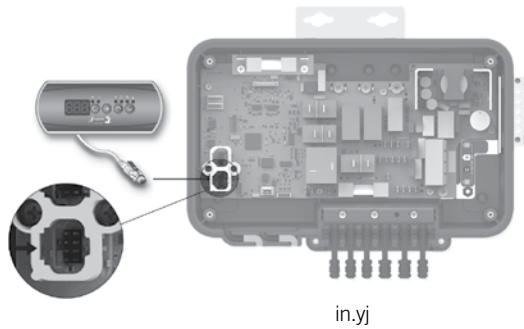

### If readings are correct and keypad is linked correctly:

- For in.yj systems, replace fuse (F2).
- For in.ye, in.yt and in.xe control systems, verify the transformer fuse.
- Replace the transformer fuse if necessary.
- If the problem persists, replace the control system.



## The spa is not heating

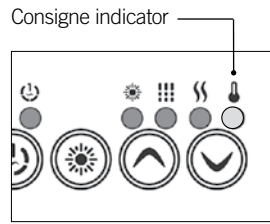

- Verify if an error message is displayed on the keypad. If so, refer to the corresponding section.
- If no message is displayed, try increasing the water temperature by setting the consigned value 2 °C above the actual water temperature. Press on the Up key to increase temperature.

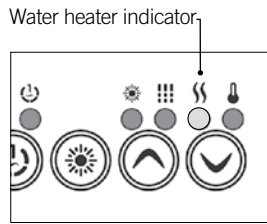

- Verify if the water heater indicator lights up.  
The water heater indicator is lit up when the water heater is active. It flashes when an increase in temperature has been demanded but the water heater has not yet started.

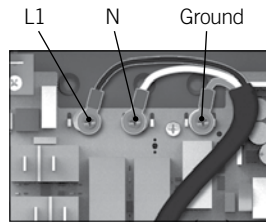

in.yj

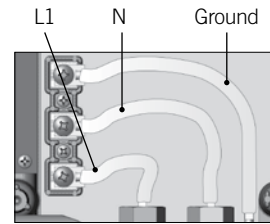

in.ye and in.yt

### If the water heater indicator lights up:

- Take voltage at the heater terminals.

For the in.yj and in.ye, in.yt, you should measure:

240 V: between the line (L1) and neutral (N) for control systems configured for 240V.

120 V: between the line (L1) and neutral (N) for control systems configured for 120 V .

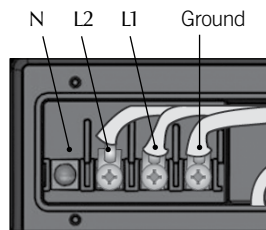

in.xe - 240 V water heater  
(5,5kW, 4 kW or 2 kW)

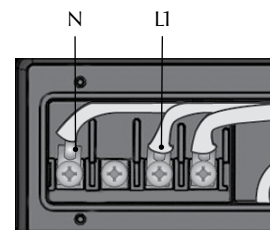

in.xe - 120 V water heater  
(1 kW)

For in.xe control systems, you should measure:

240 V: between line 1 (L1) and line 2 (L2)

120 V: between line 1 (L1) and neutral (N)

**For North American control systems, if the measured tension is not correct, verify that the water heater terminals are correctly plugged in.**

**If they are correct replace the control system.**

## Troubleshooting

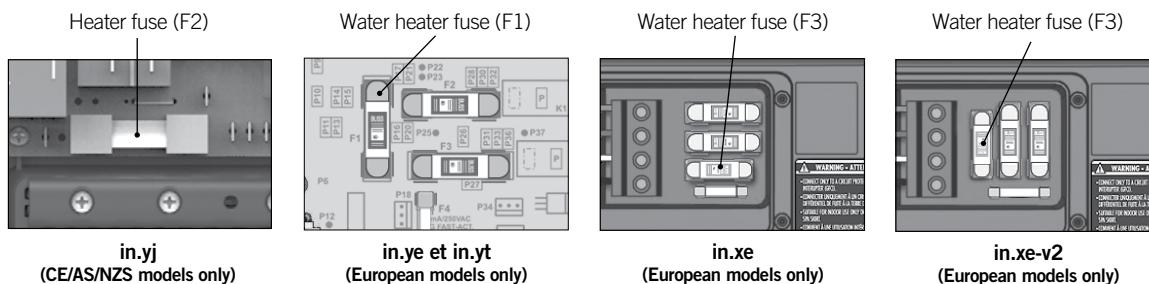

**For European control systems, if the measured tension is not correct, replace the water heater fuse.**

**in.yj - F2 fuse**

**in.ye and in.yt – Fuse F1**

**in.xe - F3 fuse**

**If the tension is correct, ensure that the water heaters power cables are correctly plugged into the control systems terminal block. If so, replace the water heater.**

**If the water heater indicator does not display on the keypad, measure the water temperature and compare with the displayed temperature:**

- If the difference is lower than 2°F (1,1 °C), there is not problem.
- If the difference is higher than 2°F (1,1 °C), replace the water heater.

If the problem persists, replace the control system.

### The keypad does not seem to work

If the keypad does not seem to work:

- Verify the keypad connections and try with a replacement keypad.
- Replace the keypad if the replacement keypad fixes the problem.
- Replace the control system if problem persists.

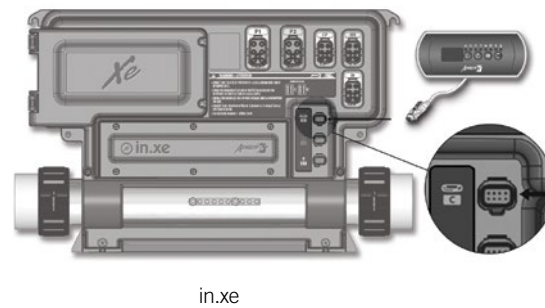
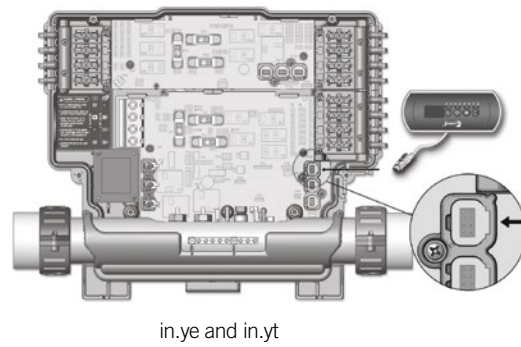
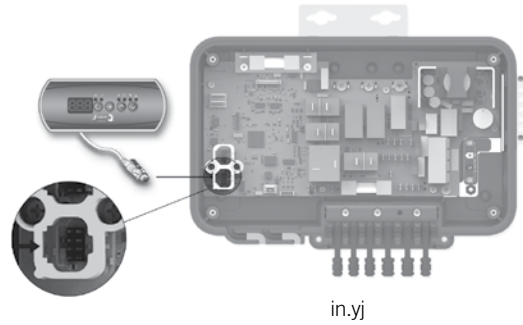

## Troubleshooting

### GFCI/RCD trips

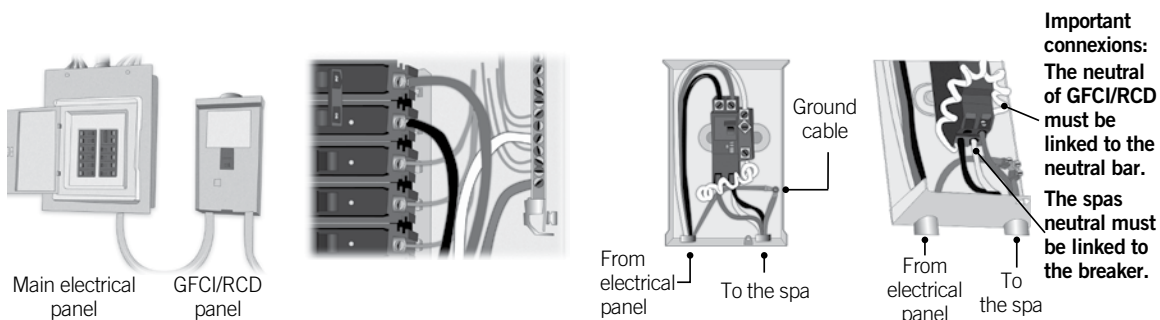

#### Warning

##### **Total current output cannot exceed total input current rating!**

There are different models of GFCI/RCD on the market. Refer to the manufacturers instructions for details on the GFCI/RCD characteristics. Note that the illustrations are given as examples only.

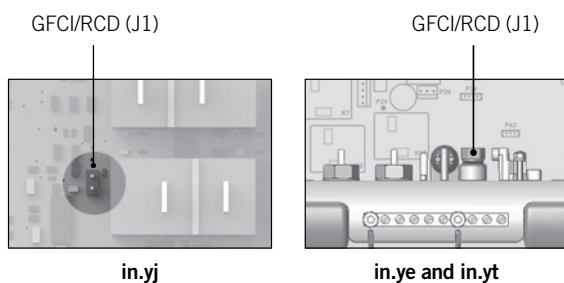

**The Y series systems are equipped with a GFCI/RCD tripper circuit in case an HL error occurs.**

- For the in.yj control systems, the GFCI/RCD tripper circuit (J1) is placed on the card, close to the K5 relay; localise it and remove the jumper.
- For the in.ye/yt, the GFCI/RCD tripper circuit (J1) is placed on the card, behind the temperature probe; localise it and remove the jumper.
- Reset the GFCI/RCD and see if the error occurs.
- If an HL error displays, follow the trouble shooting steps (in the HL error section).
- If no error occurs, reinstall the jumper.

*Note : If the GFCI/RCD trips only when jumper (J1) is installed, replace the spa pack.*

**The GFCI/RCD trips and the jumper (J1) is not installed; the error does not come from the GFCI/RCD tripper circuit.**

- Ensure the breaker circuit is connected properly.
- If it is not, reconnect it.
- Verify the cable connexions of the spa (ensure that the neutral and ground are not inverted).

**If the connexion is correct but the GFCI/RCD still triggers:**

- Unplug all system outputs (pump, blower, water heater, ozonator, etc.).
- If the GFCI/RCD does not trigger when all outputs are unplugged, reconnect the outputs one by one until the GFCI/RCD trips again.
- Replace the defective parts.

**Note: In case of a faulty connection, the GFCI/RCD may NOT trigger when it should and expose the user to an electrical choc. Only qualified personnel may intervene on the electrical installations.**



9919-101313-B  
Rev. 01-2019

© Groupe Gecko Alliance inc., 2019  
All trademarks or registered trademarks  
are the property of their respective owners.

Gecko Alliance  
450 des Canetons, Quebec City (Qc), G2E 5W6 Canada, 1.800.78.GECKO  
[www.geckoalliance.com](http://www.geckoalliance.com)

Printed in Canada