

CLIM8ZONE™



Installation Guide

Your Single Source Solution

THANK YOU

for using Balboa Water Group spa controls.

Please visit us at
www.BalboaWaterGroup.com



TABLE OF CONTENTS

04	WARNING
06	CLIM8ZONE™ DIMENSIONS
08	MINIMUM CLEARANCES
09	COMPATIBILITY MOUNTING
10	CONCRETE SLAB
12	PLATFORM ELECTRICAL CONNECTIONS
14	NORTH AMERICA
16	UK, EUROPE, AUSTRALIA, NEW ZEALAND AND REST OF THE WORLD
	PLUMBING
20	SPA EQUIPMENT DIAGRAM
22	WATER FLOW
26	PUMP UNION
28	CONDENSATION DRAIN

WARNING

ATTENTION

- This manual includes all the necessary information about the use and the installation of the CLIM8ZONE unit.
- The installer follow the installation instructions contained in the guide. Improper installation will void the warranty.
- The manufacturer declines any responsibility for the damage caused by people, objects and errors due to the installation against the manual. Any use that isn't in accordance with the origin of its manufacturing will be regarded as dangerous.

WARNING

- Do not use means to accelerate the defrosting process, other than those recommended by the manufacturer.

- The appliance shall be stored in a room without continuously operating ignition sources (for example: open flames, an operating gas appliance or an operating electric heater.)
- Do not pierce or burn.
- Be aware that refrigerants may not contain an odor.
- The CLIM8ZONE unit shall be installed, operated and stored in an open room larger than 3 m³.
- Note the manufacturer may provide other suitable examples or may provide additional information about the refrigerant odor.

WARNING

- If you power Off the CLIM8ZONE unit, please empty the water in heat pump always during winter time or when the ambient temperature drops below 0°C, or else the titanium heat exchanger will be damaged because of being frozen, in such case, your warranty will be lost.

WARNING

- Please always cut the power supply if you want to open the cabinet to reach inside the CLIM8ZONE unit, because there is high voltage electricity inside.

WARNING

- Please keep the display controller in a dry area, or close the insulation cover to protect the display controller from being damaged by humidity.

WARNING

- Installation must be performed in accordance with the NEC/CEC and local code by authorized person only.

WARNING

- Make sure the switch is turned to the power off position before installing the CLIM8ZONE unit or maintenance the heat pump.

WARNING

- This appliance is not intended for use by persons (including children) with reduced physical, sensory or mental capabilities, or lack of experience and knowledge, unless they have been given supervision or instruction concerning use of the appliance by a person responsible for their safety.
- Children should be supervised to ensure that they do not play with the appliance.

WARNING

- Single wall heat exchanger, not suitable for potable water connection.

CLIM8ZONE™

DIAGRAM & DIMENSIONS

1	Enclosure Lid
2	Mounting Feet
3	Fan
4	Air Vents
5	Condensation Drain Spout
6	Lid Screws
7	Water Output
8	Water Input
9	Control / Data Bus
10	Power Line Box
11	Bonding Lugs (North America)

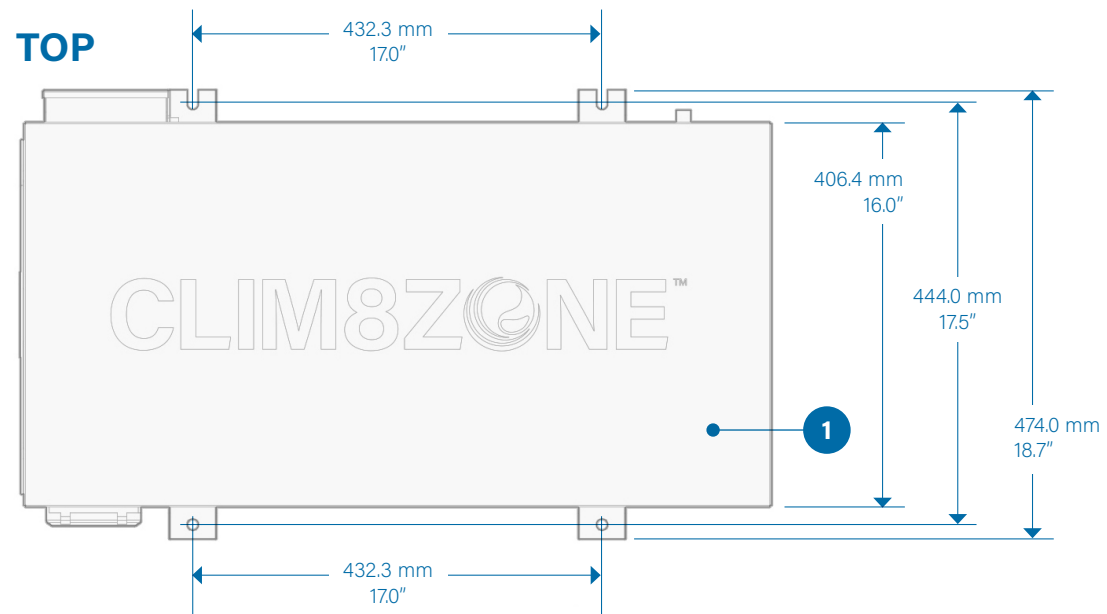

Figure 1

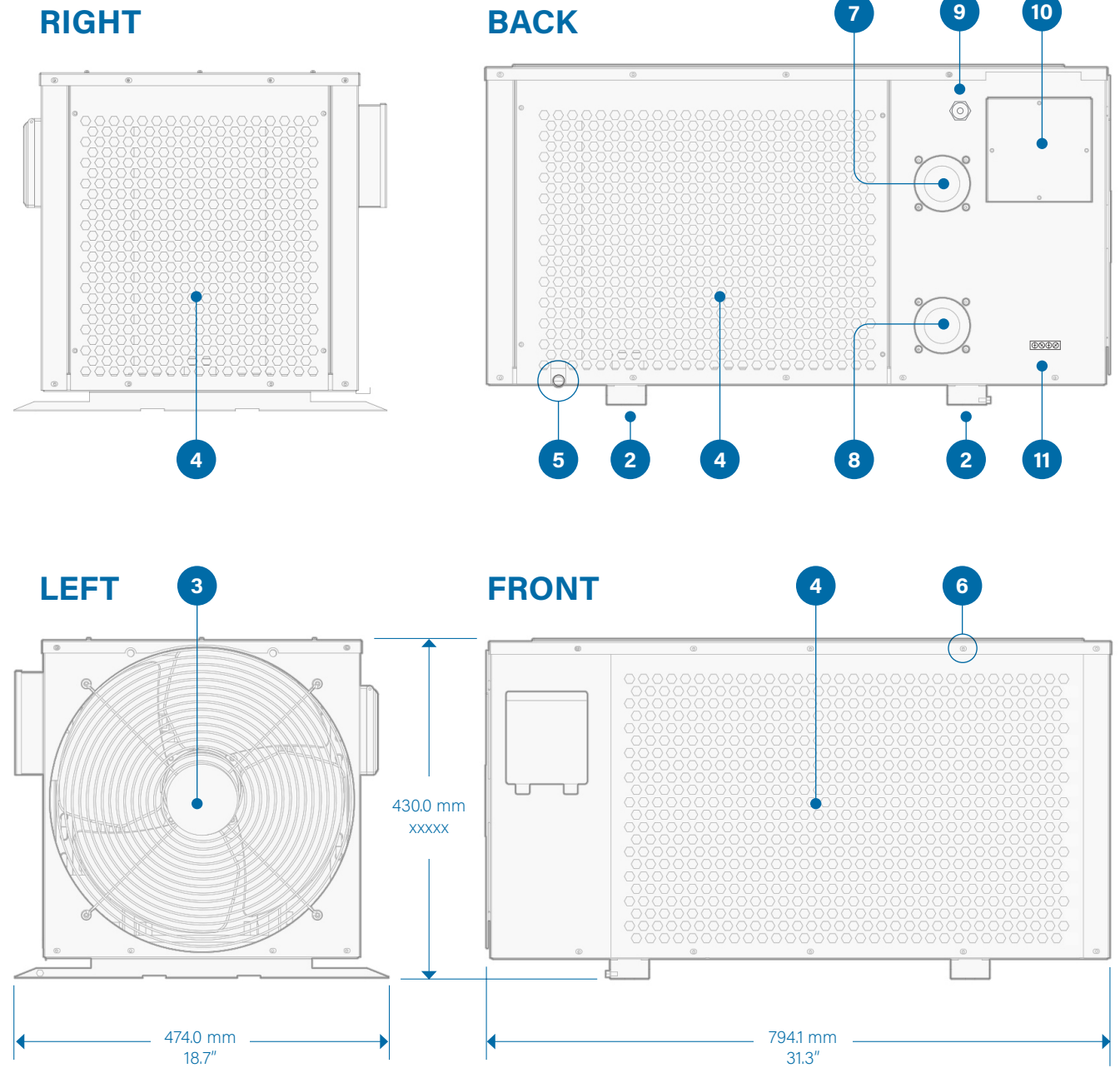

Figure 2

MINIMUM CLEARANCES

Follow the minimum clearance requirements shown below during installation and operation of the CLIM8ZONE™ unit. These clearances insure proper air flow. All air vents must be unobstructed and free of debris.

DO NOT install the CLIM8ZONE™ unit indoors.

It is recommended that the CLIM8ZONE™ unit be installed no more than 6.5 feet (2 meters) from the Hot Tub.

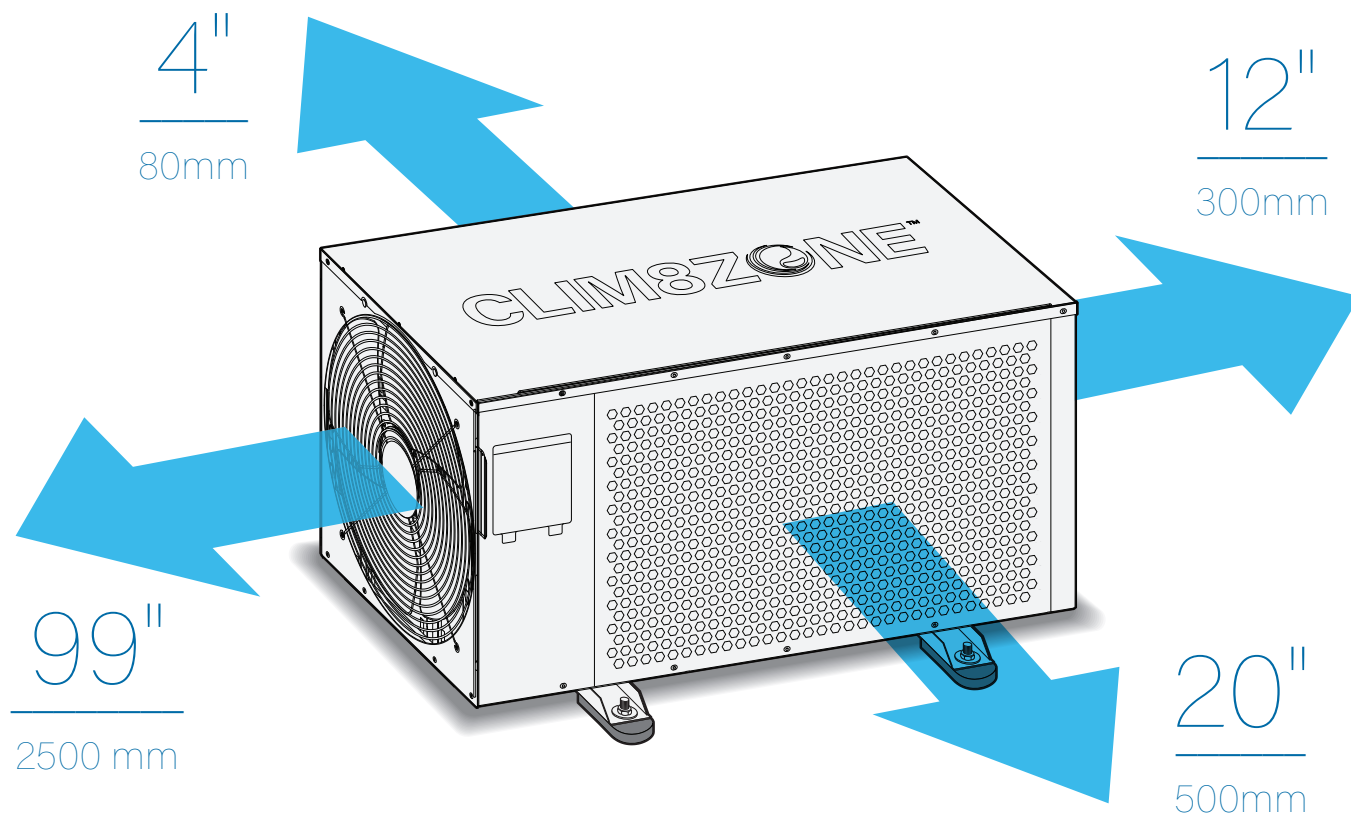

Figure 3

COMPATIBILITY

CLIM8ZONE™ is compatible with the following spa controls.

BP CONTROL SYSTEMS

The CLIM8ZONE™ unit is compatible with BP Control Systems that have one of the following agency prefixes: BP20, BP21, BP501, BP6, BP2, BP1. The agency prefix is noted on the control system identification label

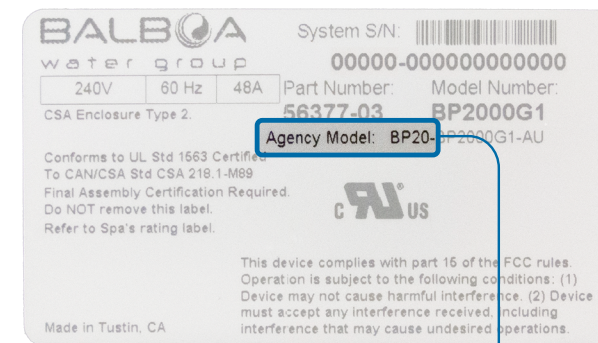

BP Control System Identification label



AGENCY PREFIX

The agency prefix is noted on the identification label, which is on the top surface of the system pack. In this example the agency prefix is BP20.

CONTROL PANELS

SpaTouch™3



SpaTouch™3 Mini (Launching in 2022)



TP700



Updated BP Control System software and control panel software is required for CLIM8ZONE

Please visit us at www.BalboaWaterGroup.com

MOUNTING

CONCRETE SLAB

Follow these steps to mount the CLIM8ZONE™ unit to the platform.

1 - Establish the location of the CLIM8ZONE™ unit on the concrete slab.

DO NOT install the CLIM8ZONE™ unit indoors.

It is recommended that the CLIM8ZONE™ unit be installed no more than 6.5 feet (2 meters) from the Hot Tub.

Follow the minimum clearance requirements (figure 3) to insure proper air flow.

2 - Each foot (figure 4, A) on the CLIM8ZONE™ unit has a mounting hole. Clearly mark the center of each mounting hole on the concrete slab. Move the CLIM8ZONE™ unit to make room for step 3.

3 - Using the marks from step 2 as a guide, drill one mounting hole for each foot into the concrete slab (figure 4, F).

4 - Clean the mounting holes (figure 4, G) and the cement slab, removing all dust and debris. If necessary use compressed air to clean the mounting holes.

5 - Move the CLIM8ZONE™ unit back into its final position, making sure the mounting holes in the cement slab align with the corresponding mounting holes in the feet.

6 - Place a foot pad (figure 4, C) under each foot.

7 - Install the washer (figure 4, B), expansion wedge anchor (figure 4, E) and nut (figure 4, D) on each foot (A). Make sure the expansion wedge nuts are fully seated into the mounting holes (figure 4, H); use a rubber mallet if necessary.

8 - Tighten each expansion wedge anchor by turning the nut (figure 4, I).

Mounting hardware not included.

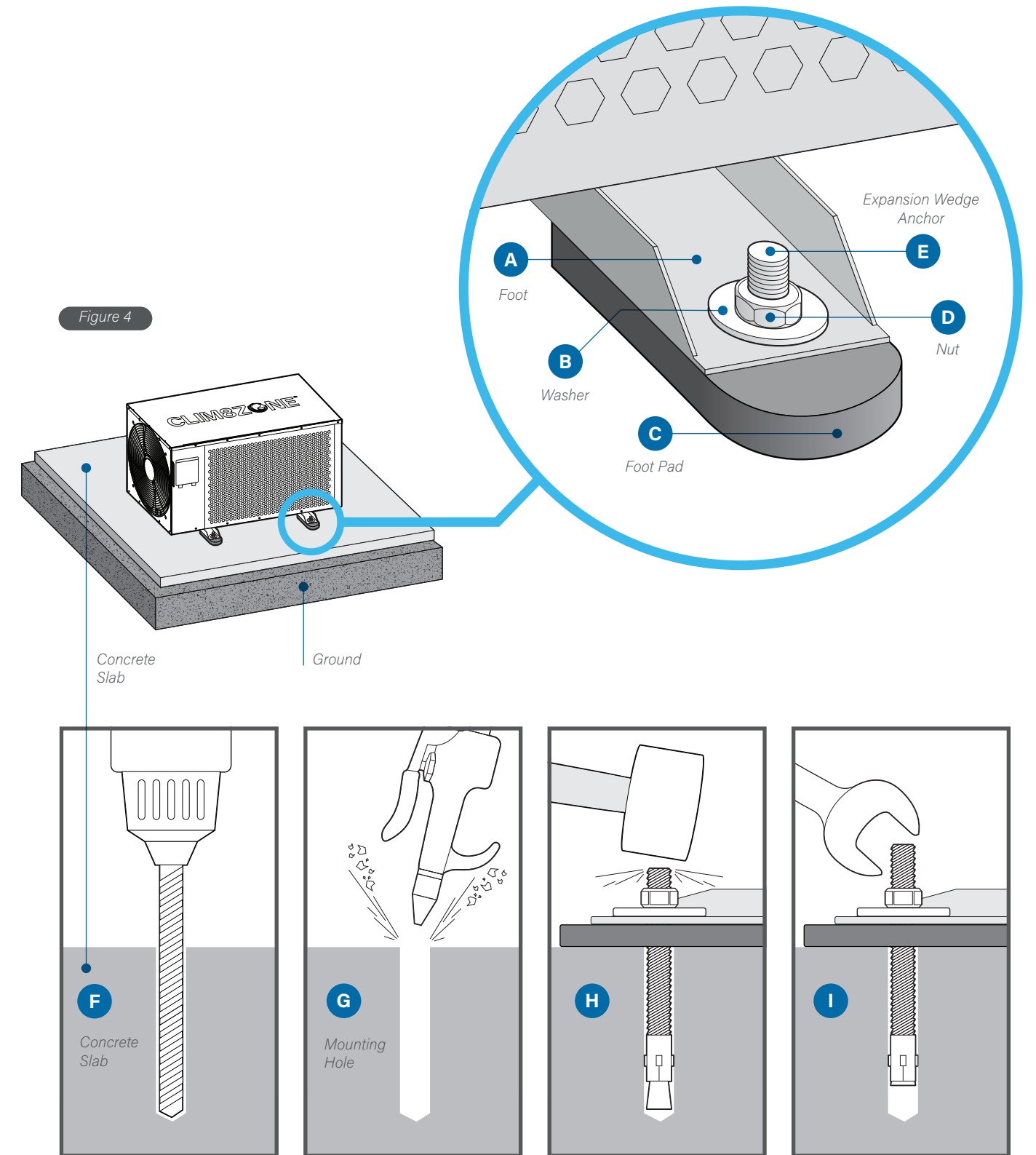

MOUNTING PLATFORM

Follow these steps to mount the CLIM8ZONE™ unit to a platform.

1 - Establish the location of the CLIM8ZONE™ unit on the platform (figure 5, A). Each foot on the CLIM8ZONE™ unit has a mounting hole (figure 5, A). Clearly mark the center of each mounting hole on the platform (figure 5, A). In the next step you will drill a mounting hole for each foot (four total).

DO NOT install the CLIM8ZONE™ unit indoors.

It is recommended that the CLIM8ZONE™ unit be installed no more than 6.5 feet (2 meters) from the Hot Tub.

Follow the minimum clearance requirements (figure 3) to insure proper air flow.

2 - Using the marks from step 1 as a guide, drill one mounting hole for each foot into the platform (figure 5, B).

3 - Clean the mounting holes and the platform (figure 5, C), removing all dust and debris.

4 - Move the CLIM8ZONE™ unit back to its final position, making sure the mounting holes in the platform align with the corresponding mounting holes in the feet.

5 - Place a rubber foot pad under each foot (figure 4, C). Rubber foot pads dampen vibrations.

6 - Install the washers, bolt and nut on each foot (figure 5, D).

7 - Tighten the nut (figure 5, E) on each foot.

Mounting hardware not included.

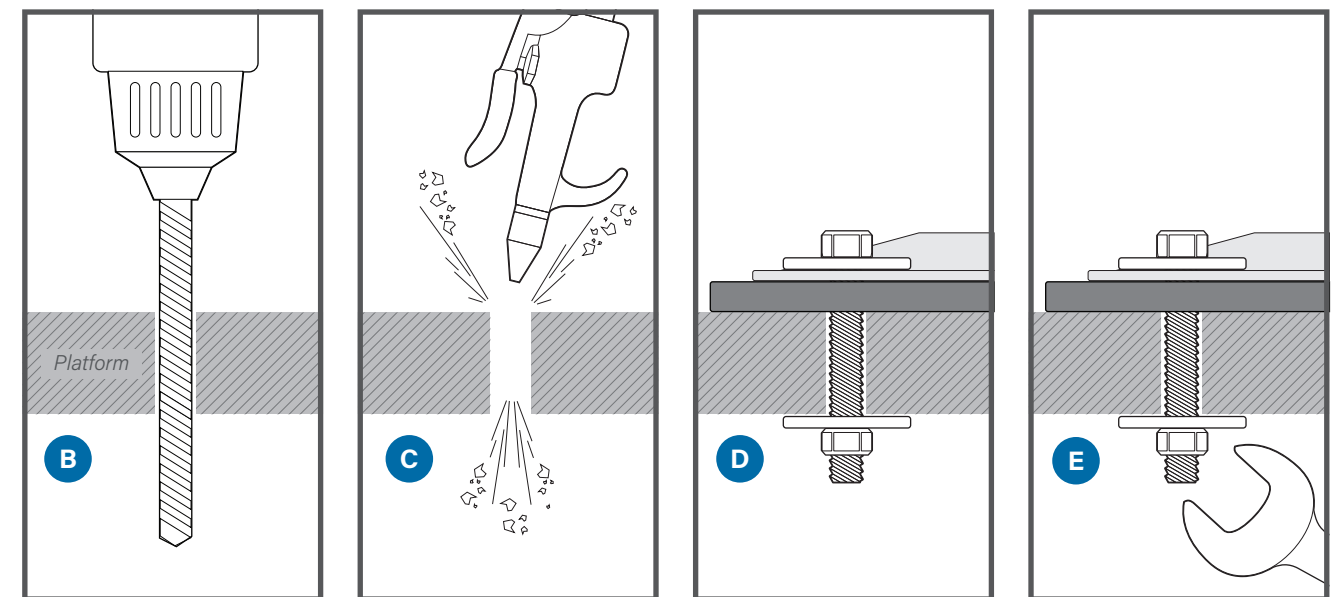
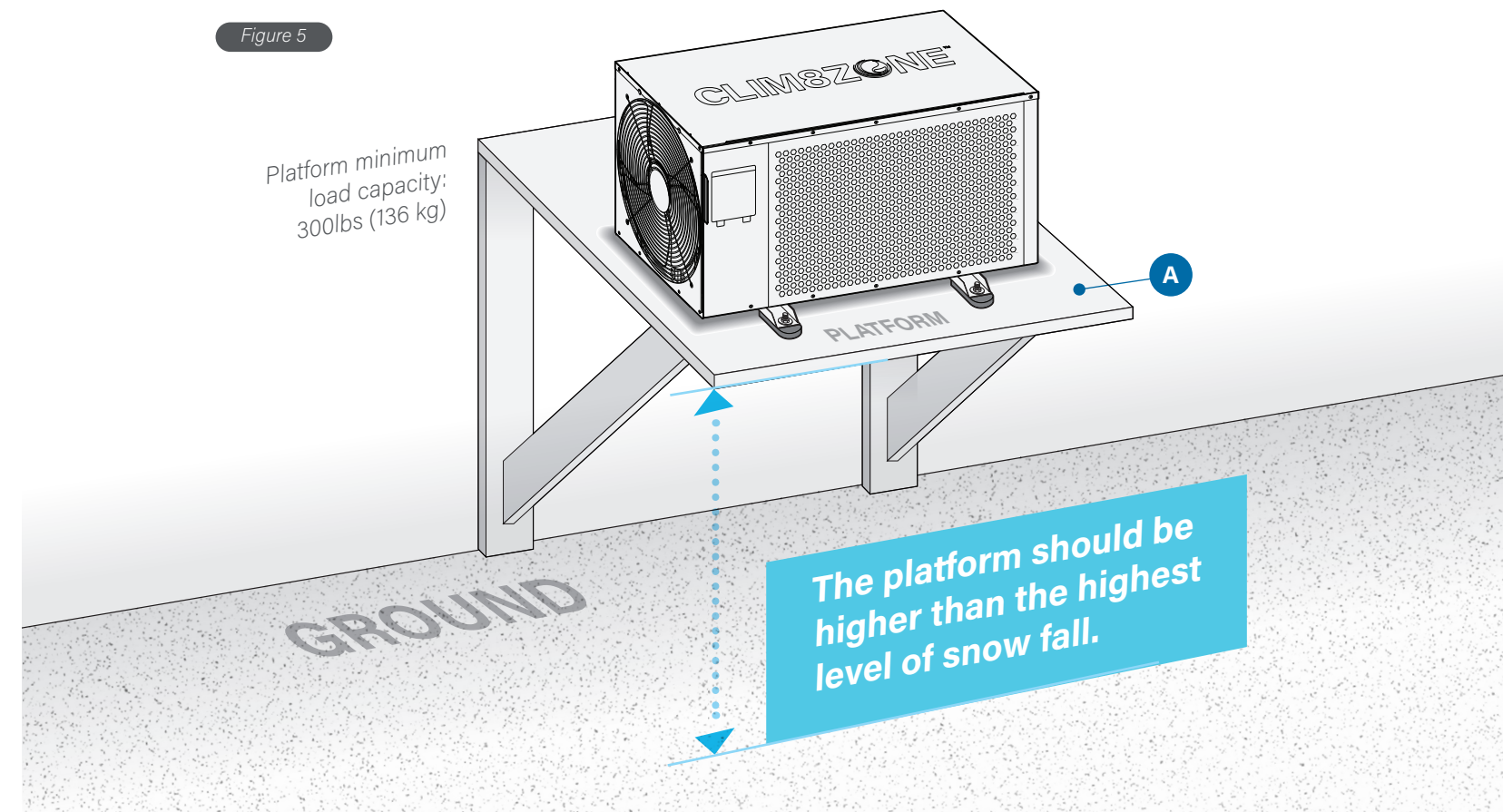

ELECTRICAL CONNECTIONS

NORTH AMERICA

⚠ WARNING

There are no user serviceable parts inside of the CLIM8ZONE™ unit or the control system. All connections must be made by a qualified electrician in accordance with the country or local electrical codes in effect at the time of installation.

IMPORTANT

- Earthing is required for protection against short-circuits inside the unit. Always provide a good earth connection.
- Before connecting the unit, verify that the supply voltage matches the required voltage of the heat pump.
- It is recommended to connect the heat pump to a circuit with its own fuse or circuit breaker.

CLIM8ZONE™ MAXIMUM CURRENT:

220-240 VAC
50-60 Hz
5.71 A

Follow these steps to make the electrical connections:

1 - Make sure the BP Control System (figure 6, B) is powered Off at the GFCI or circuit breaker before starting the installation process.

2 - Remove the lid from the BP Control System (figure 6, B) by loosening these two screws (figure 6, C) with a Phillips head screwdriver.

There is a wiring diagram in the inside surface of the lid. Refer to the wiring diagram during steps 3 and 4.

3 - Connect the power cord (figure 6, D) to the circuit board of the BP Control System (figure 6, B). Refer to the wiring diagram for the proper connection. The connectors are keyed, so make sure they are properly aligned (figure 6, F) before making the connection.

4 - Connect the data bus (figure 6, E) to the circuit board of the BP Control System (figure 6, B). Refer to the wiring diagram for the proper connection. The connectors are keyed, so make sure they are properly aligned (figure 6, F) before making the connection.

5 - Reinstall the lid of the BP Control System (figure 6, B).

6 - Bonding: This unit is provided with a grounding lug (figure 6, G) and must be electrically bonded to the spa common bonding grid.

Connect the grounding lug with the spa common bonding grid with a #8 minimum solid copper wire.

7 - Power On the BP Control System at the GFCI or circuit breaker.

Figure 6

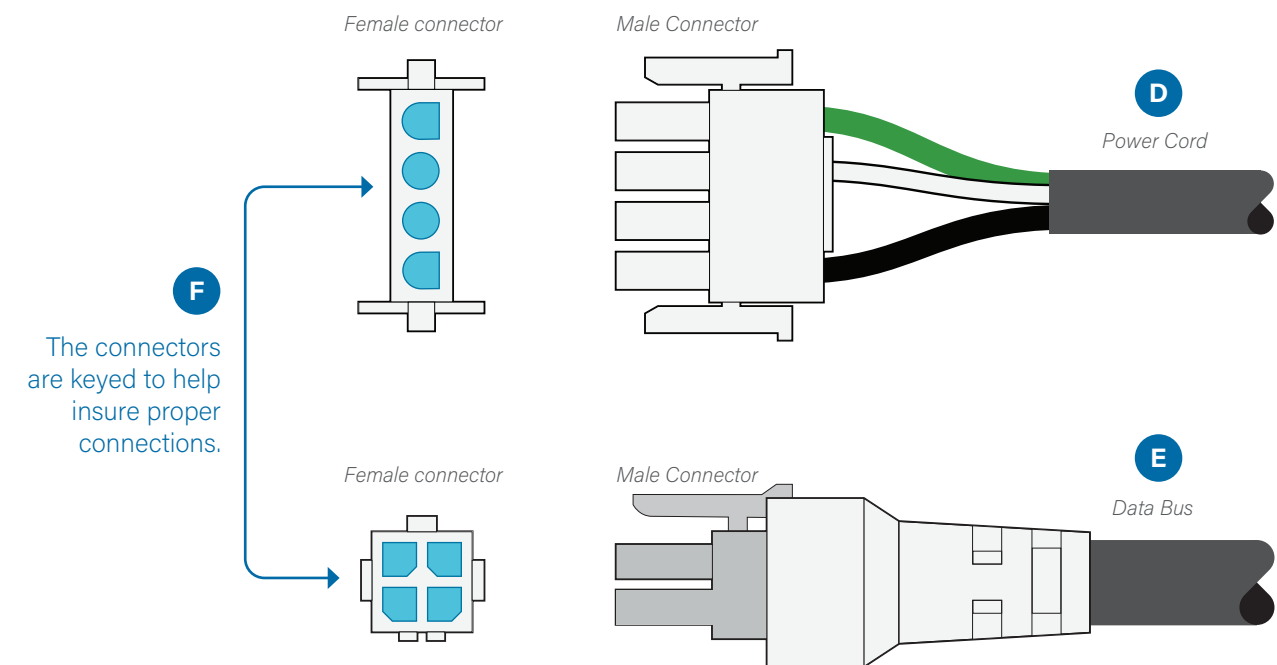
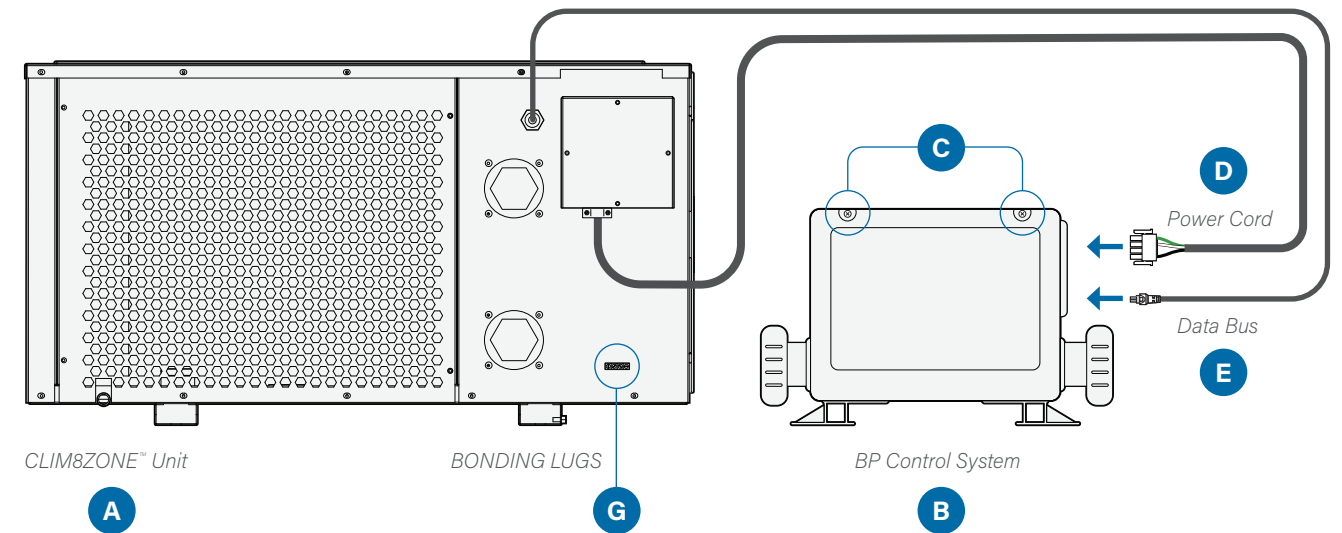

ELECTRICAL CONNECTIONS

1 SERVICE

UK, EUROPE, AUSTRALIA, NEW ZEALAND AND REST OF THE WORLD

⚠ WARNING

There are no user serviceable parts inside of the CLIM8ZONE™ unit or the control system. All connections must be made by a qualified electrician in accordance with the country or local electrical codes in effect at the time of installation.

IMPORTANT

- Earthing is required for protection against short-circuits inside the unit. Always provide a good earth connection.
- Before connecting the unit, verify that the supply voltage matches the required voltage of the heat pump.
- It is recommended to connect the heat pump to a circuit with its own fuse or circuit breaker.

CLIM8ZONE™ MAXIMUM CURRENT:

220-240 VAC
50-60 Hz
5.71 A

Follow these steps to make the electrical connections:

1 - Make sure the BP Control System (figure 7, B) is powered Off at the RCD or circuit breaker before starting the installation process.

2 - Remove the lid from the BP Control System (figure 7, B) by loosening these two screws (figure 7, C) with a Phillips head screwdriver.

There is a wiring diagram in the inside surface of the lid. Refer to the wiring diagram during steps 3 and 4.

3 - Connect the power cord (figure 7, D) to the circuit board of the BP Control System (figure 7, B). Refer to the wiring diagram for the proper connection. The connectors are keyed, so make sure they are properly aligned (figure 7, F) before making the connection.

4 - Connect the data bus (figure 7, E) to the circuit board of the BP Control System (figure 7, B). Refer to the wiring diagram for the proper connection. The connectors are keyed, so make sure they are properly aligned (figure 7, F) before making the connection.

5 - Reinstall the lid of the BP Control System (figure 7, B).

6 - Power On the BP Control System at the RCD or circuit breaker.

Figure 7

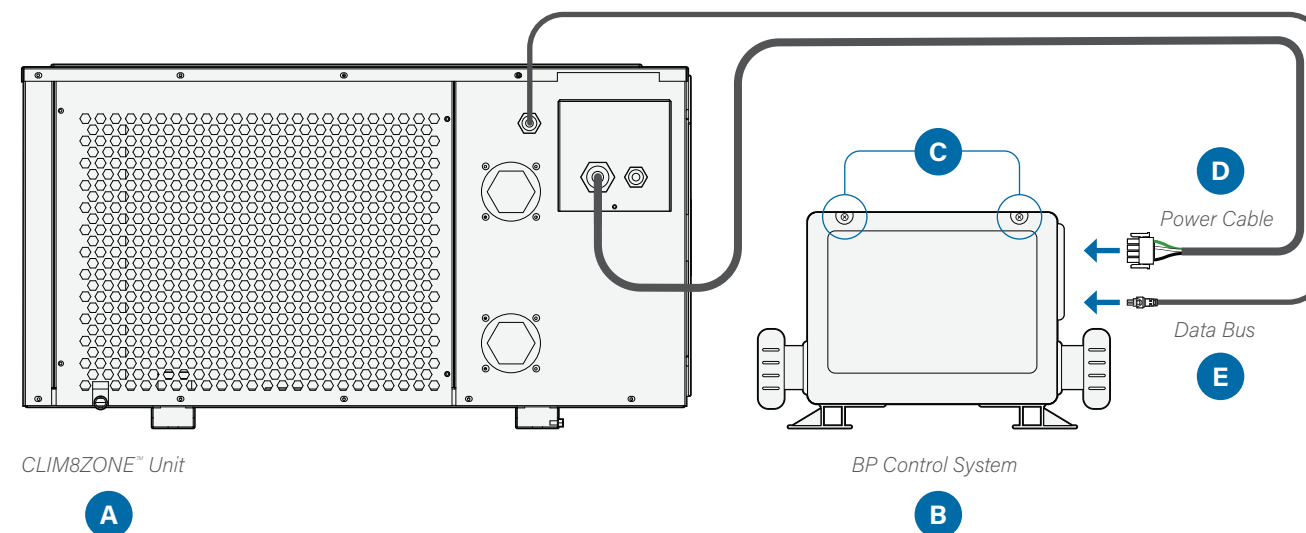

A

B

F

The connectors are keyed to help insure proper connections.

Female connector

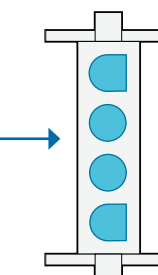

Male Connector

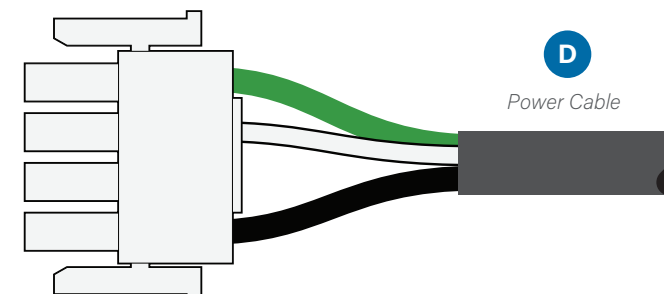

Female connector

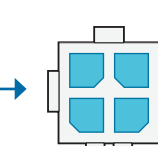

Male Connector

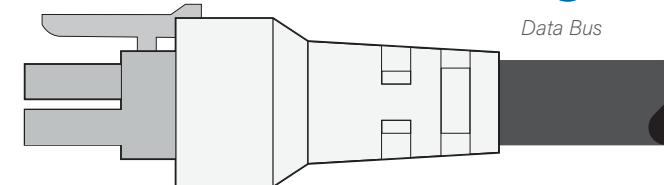

ELECTRICAL CONNECTIONS

3 SERVICE

UK, EUROPE, AUSTRALIA, NEW ZEALAND AND REST OF THE WORLD

⚠ WARNING

There are no user serviceable parts inside of the CLIM8ZONE™ unit or the control system. All connections must be made by a qualified electrician in accordance with the country or local electrical codes in effect at the time of installation.

IMPORTANT

- Earthing is required for protection against short-circuits inside the unit. Always provide a good earth connection.
- Before connecting the unit, verify that the supply voltage matches the required voltage of the heat pump.
- It is recommended to connect the heat pump to a circuit with its own fuse or circuit breaker.

CLIM8ZONE™ MAXIMUM CURRENT:

220-240 VAC
50-60 Hz
5.71 A

Follow these steps to make the electrical connections:

1 - Make sure the BP Control System (figure 8, B) is powered Off at the RCD or circuit breaker before starting the installation process.

2 - Remove the lid from the BP Control System (figure 8, B) by loosening these two screws (figure 8, C) with a Phillips head screwdriver.

There is a wiring diagram in the inside surface of the lid. Refer to the wiring diagram during steps 3 and 4.

3 - Connect the power cable (figure 8, D) to the adaptor (figure 8, F). Connect the adaptor to the circuit board of the BP Control System (figure 8, B). Refer to the wiring diagram for the proper connection. The connectors are keyed, so make sure they are properly aligned (figure 8, F) before making the connections.

4 - Connect the data bus (figure 8, E) to the circuit board of the BP Control System (figure 8, B). Refer to the wiring diagram for the proper connection. The connectors are keyed, so make sure they are properly aligned (figure 7, F) before making the connection.

5 - Reinstall the lid of the BP Control System (figure 8, B).

6 - Power On the BP Control System at the RCD or circuit breaker.

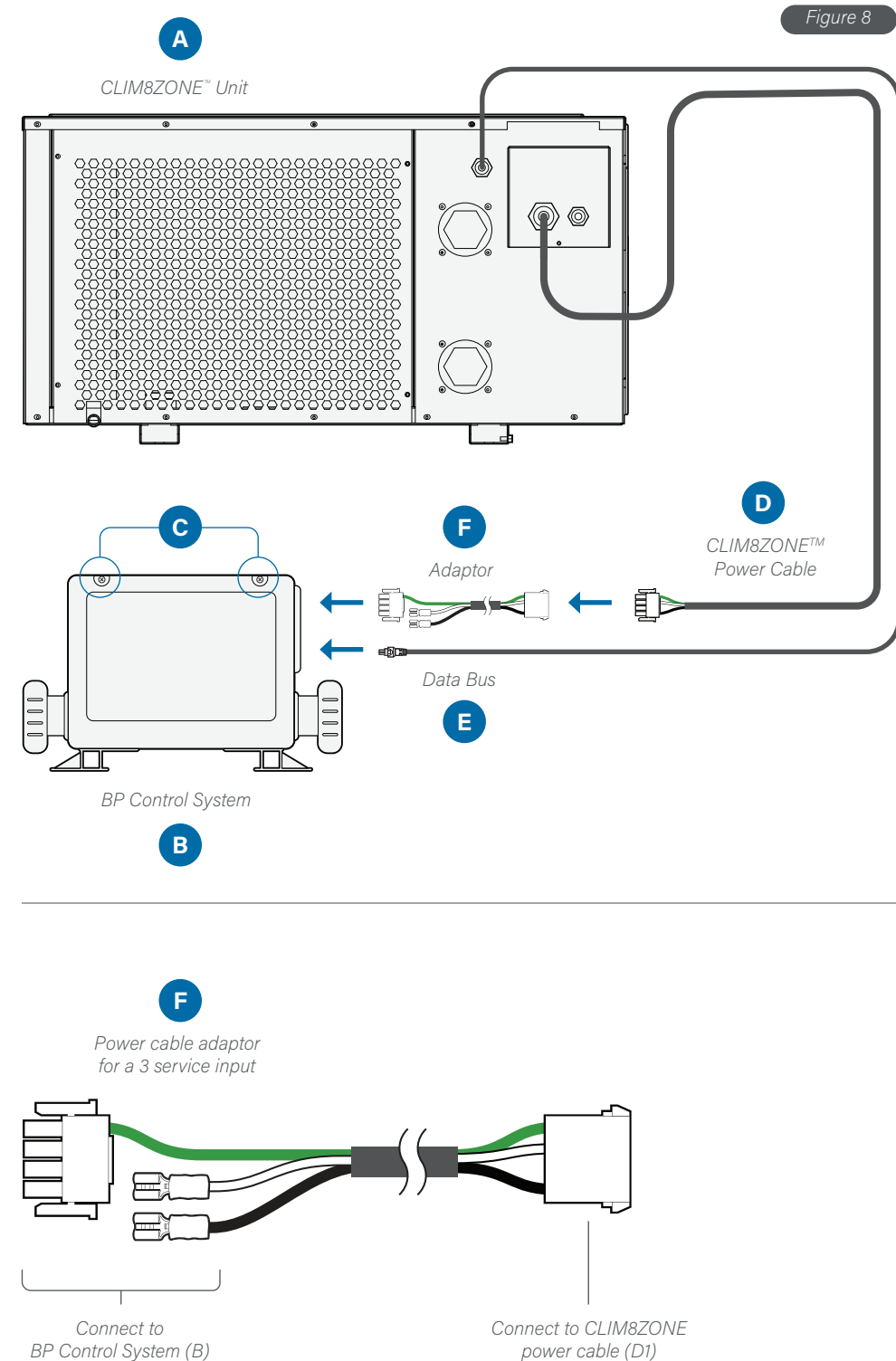

SPA EQUIPMENT DIAGRAM

Figure 9

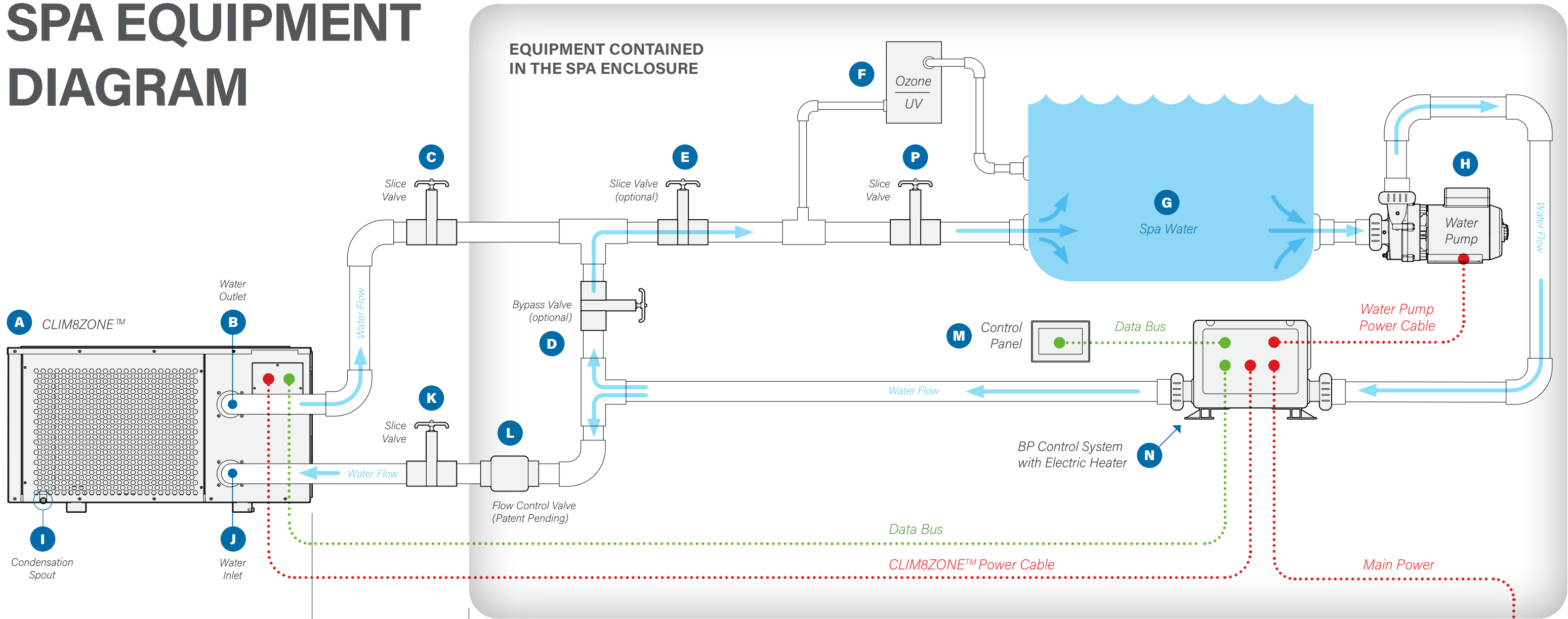

DIAGRAM KEY

- Data Bus ●.....●
- Power ●.....●
- Water Flow Direction →

6.5" / 2M
Recommended distance between the CLIM8ZONE™ unit and the spa enclosure.

SPA EQUIPMENT	
A	CLIM8ZONE™ Unit
B	Water Outlet
C	Slice Valve
D	Slice Valve (optional)
E	Slice Valve (optional)
F	Ozone / UV
G	Spa Water
H	Heating Pump
I	Condensation Spout
J	Water Inlet
K	Slice Valve
L	Flow Control Valve or Ball Valve
M	Control Panel
N	BP Control System
O	Main Power
P	Slice Valve

WATER FLOW

THREE RULES OF WATER FLOW FOR THE CLIM8ZONE™ UNIT

- 1 The CLIM8ZONE™ unit (figure xx, A) should have an input water flow of 11.9 US GPM (45 LPM) +/- 10% for optimal efficiency when heating or cooling the water.
- 2 The water flow into the CLIM8ZONE™ unit should be greater than 3.57 US GPM (13.5 LPM) to prevent a low flow error.
- 3 The water flow into the CLIM8ZONE™ unit should be less than 17.8 US GPM to ensure the unit is not damaged over extended use.

CLIM8ZONE™ Water Flow Rates	US Gallons Per Minute	Liter Per Minute	Meter ³ /Hour
Optimal flow rate for heating/cooling	11.89	45.0	2.70
Maximum flow rate for heating/cooling (+10%)	13.08	49.5	2.97
Minimum flow rate for heating/cooling (-10%)	10.70	40.5	2.43
Maximum flow rate to prevent damage	17.83	67.5	4.05
Minimum flow rate to prevent low flow error	3.57	13.5	0.81

Water flow rate for the BP Control System:

Minimum: 23 GPM (5.22 m3/H)

The BP Control System has a minimum specified flow rate of water through the electric heater for the BP Control System to function properly. Therefore, a bypass plumbing setup with slice valves must be used in the hot tub to allow for both the flow rate requirements of the CLIM8ZONE™ unit and the flow rate requirements of the BP Control System heater to be met in the hot tub.

The installer shall adjust the water flow into the CLIM8ZONE™ unit by using the ball valve to ensure that the flow rate is within the recommended ranges.

Low or No Flow Condition

The CLIM8ZONE™ unit will shut itself off for safety reasons anytime the sensed water flow through the Heat Pump falls below a threshold of 3.6 GPM (0.81 m3/h).

During a Low/No Flow condition, the CLIM8ZONE™ unit will not heat or cool the water and will display an error message on the control panel display.

High Temperature Safety Protection

The CLIM8ZONE™ unit will shut off all heating or cooling for safety reasons anytime the water temperature exceeds 43°C/109.4°F for 5 seconds at the outlet or inlet.

Ozone / UV

Make sure any ozone / UV units are installed down stream from the CLIM8ZONE™ unit (Figure 9, F).

HEATING PUMP & FLOW CONTROL VALVE CONFIGURATION CHART

General Pump Type	HIGH Speed Amps	LOW Speed Amps	Flow Control Valve with 1.5" Plumbing	Flow Control Valve with 2" Plumbing	Flow Control Valve with 2.5" Plumbing
1.05A CIRC 60Hz		1.05	73002	73003	NO
1.00A CIRC 60Hz		1.00	73002	73003	NO
0.63A CIRC 60Hz		0.63	NO	73003	NO
16/4 56 Frame 60Hz	16.4	4.8	NO	73002	73002
16/4 56 Frame "Circ Killer" 60Hz	14	1.1	73002	73003	NO
12/2 56 Frame 60Hz	12.1	2.0	NO	73002	73002
12/4.4 56 Frame 60Hz	12	4.4	NO	73002	73002
12/3.5 "XL" with Larger Impeller 60Hz	12	3.5	NO	73002	73002
12/1 56 Frame "Circ Killer" 60Hz	12	1.0	73002	73003	NO
10/3 48 Frame 60Hz	10.7	3.0	NO	73002	73002
8.8/3 48 Frame 60Hz	8.8	3.0	73002	73002	NO

73002: Flow Control Valve, High Amp

73003: Flow Control Valve, Low Amp

NO: Cannot use this pump

Patent Pending

FLOW CONTROL VALVE OPTIONS

Part number: 73002, High Amp (*Patent Pending*)
 Part number: 73003, Low Amp (*Patent Pending*)

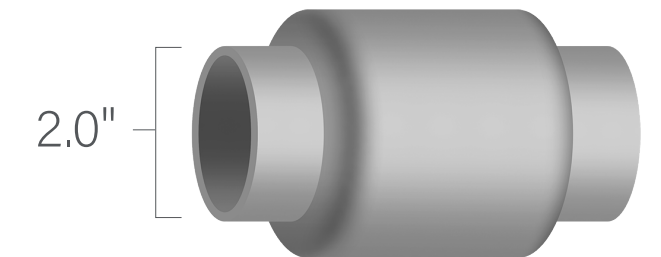

Figure 10

There are two ways to manage water flow into the CLIM8ZONE™ unit:

- 1 Install a ball valve (figure 11, L). This requires manual adjustments by the installer. A circulation pump should be used as the heating pump. A two-speed pump is incompatible with a ball valve setup.
- 2 Install a flow control valve (figure 11, L) - *Patent Pending*. The flow control valve automatically adjusts water flow into the CLIM8ZONE™ unit. A circulation pump or two-speed pump can be used as a heat pump in a flow control valve setup.

HEAT PUMP vs HEATING PUMP

HEATING PUMP

A heating pump (figure 11, H) is a water pump that circulates water through the electric heater contained in the BP Control System (figure 11, N). The heating pump does not contain a heating element. It is simply a water pump.

There are two types of heating pumps:

- 1 - Circulation pump
- 2 - Two-speed pump.

If the spa has a two-speed heating pump, it will circulate water at low speed through the electric heater.

HEAT PUMP

A heat pump can both heat or cool spa water, and all of the heating and cooling equipment is contained in the heat pump. CLIM8ZONE (figure 11, A) is a heat pump.

Figure 11

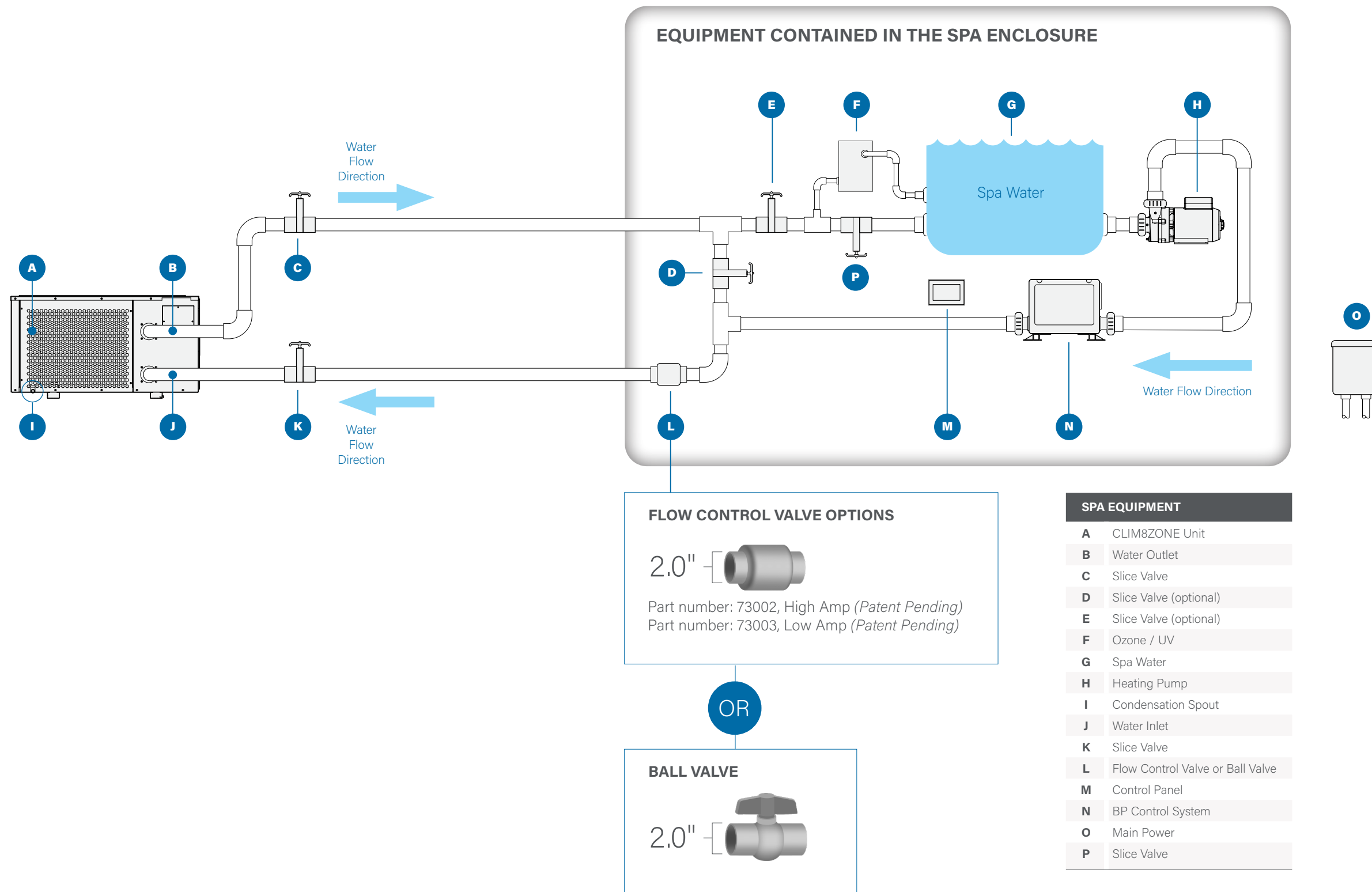

PLUMBING

ITEMS INCLUDED IN THE BOX

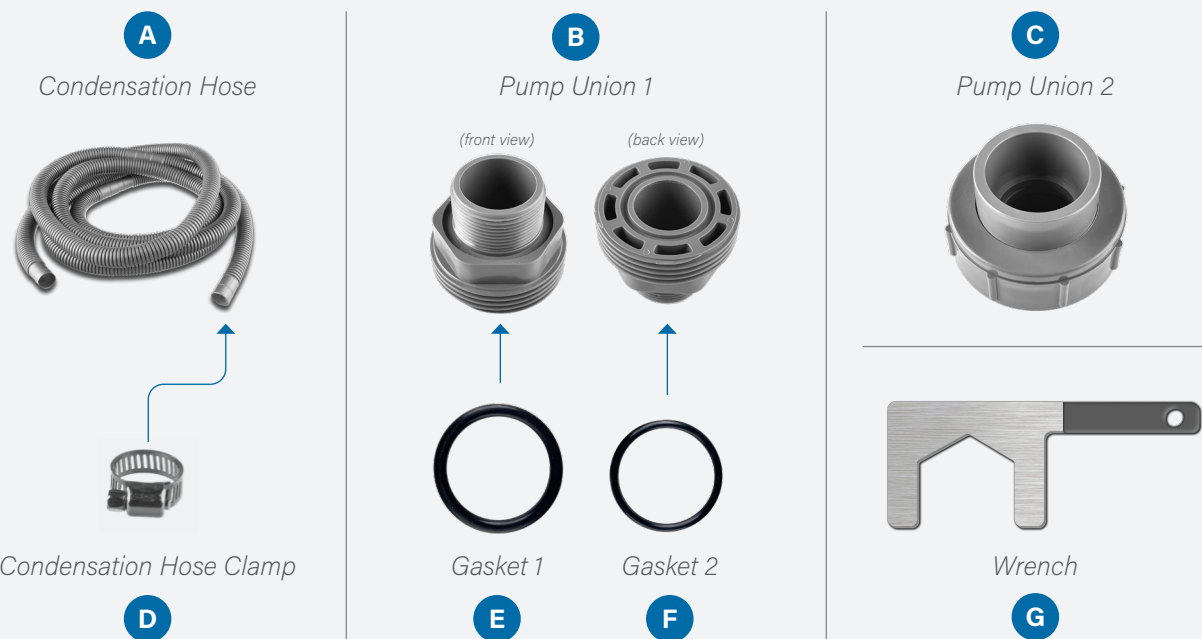
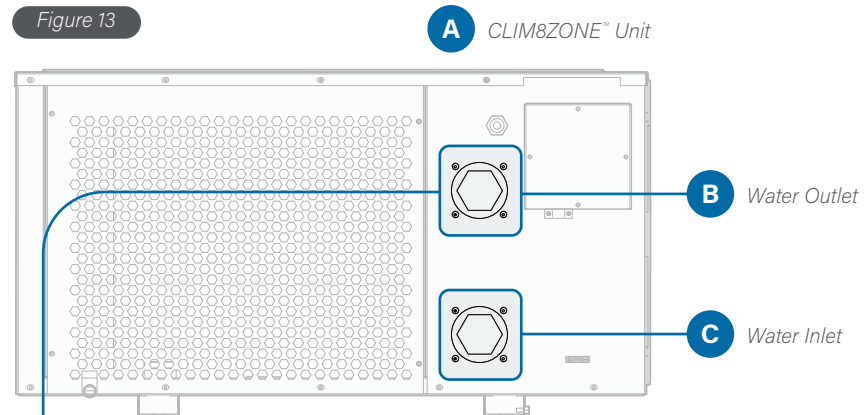
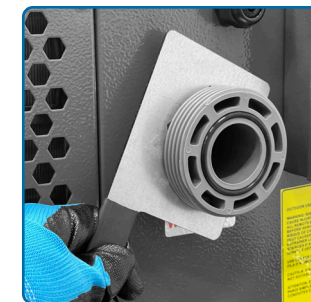

Figure 12



Install pump unions

The CLIM8ZONE unit (figure 13, A) has a cap covering the water outlet as shown here.



3 Tighten Pump Union 1 with the wrench (figure 12, G) as shown here. Wear gloves to protect your hands from the edges of the wrench.

Before beginning step 4, make sure Gasket 2 (figure 12, F) is still properly seated as shown here.



1 Remove the cap as shown here.



4 Install Pump Union 2 (figure 12, C) onto the end of Pump Union 1 as shown here.

5 Repeat steps 1 - 4 for the water inlet (figure 12, C).

(Continued on next page)



2 Before starting this step, make sure Gasket 1 (figure 12, E) and Gasket 2 (figure 12, F) are mounted properly on Pump Union 1 (figure 10, B). Install Pump Union 1 into the water outlet as shown here.

Figure 14

A CLIM8ZONE™ Unit

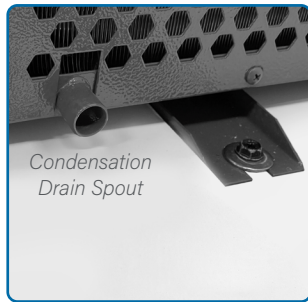
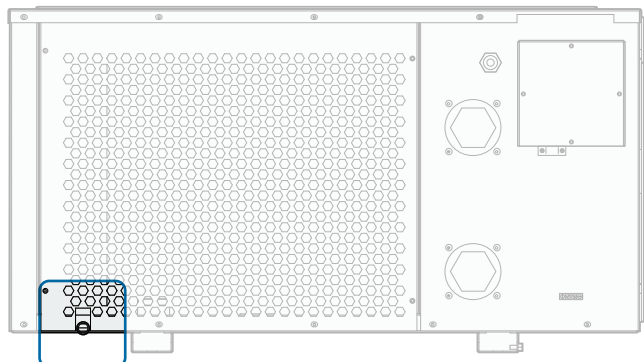

Condensation
Drain Spout

Install condensation hose

The CLIM8ZONE™ unit (figure 14, A) has a condensation drain spout as shown here.

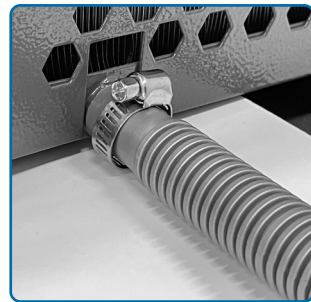

1 Install the hose and hose clamp over the drain spout as shown here.

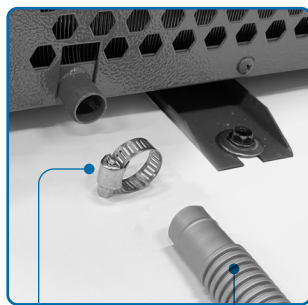

Hose Clamp

A hose clamp and condensation hose are supplied for drainage.

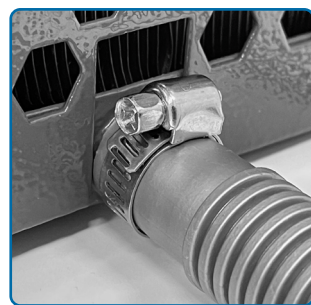

2 Tighten the hose clamp with a Philips head screw driver to secure the hose in place and create a water tight fit.

Condensation Hose



As much as 3+ liters of condensation per hour may flow from the end of the hose. Make sure the end of the hose has proper drainage, so water does not collect around the CLIM8ZONE™ unit. Condensation is normal and is not a water leak.

NOTES



CLIM8ZONE™

✉ Email

info@balboawater.com

☎ Phone

P : + 714.384.0384
Customer Service is available:
M - F 7:00AM to 6:00PM PT

📍 Corporate Office

Balboa Water Group
3030 Airway Avenue
Costa Mesa, CA 92626

MEXICO OPERATIONS

Balboa Water Group
Aguila Azteca 6011
Baja Maq. El Aquila
Mexico 22221

EUROPEAN OPERATIONS

Balboa Water Group
Hydroair International
ApS Roustvej 50 DK-6800
Varde